

# RC LOG LIST

UNIT ..... MODEL ..... NO .....

This LOG LIST contains information on modifications of the basic unit, due to Options, Engineering Change Notes, and Field Change Orders.

Do not forget to list all future modifications on this page.

OPTION ECN or FCO No.	DATE of Installation	SIGN	SHORT DESCRIPTION













































# TECHNICAL MANUAL

CABLES

-----

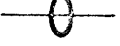
Dwg. No.

Kabeltype 1/	cm	V20716
Kabeltype 2/	cm	V20717
Kabeltype 3/	cm	V20701
Kabeltype 4/	cm	V20840
Kabeltype 5/	cm	V11089
Kabeltype 6/	cm	V11097
Kabeltype 7/	cm	V11098
Kabeltype 8/	cm	V11090
Kabeltype 9/	cm	V20836
Kabeltype 10/	cm	V20841
Kabeltype 11/	cm	V20888
Kabeltype 12/	cm	V11394
Kabeltype 13/	cm	V20974
Kabeltype 14/	cm	V20953
Kabeltype 15/	cm	V20954
Kabeltype 16/	cm	V20957
Kabeltype 17/	cm	V20958
Kabeltype 18/	cm	V20959
Kabeltype 19/	cm	V21015
Kabeltype 23/	cm	V21064
Kabeltype 24/	cm	V21083

I		II		I		II	
PIN	WIRE	PIN	PIN	WIRE	PIN		
A	 hvid	A	EE	 grå	EE		
B	 grå	B	FF	 sort	FF		
C	 hvid	C	HH	 blå	HH		
D	 sort	D	JJ	 hvid	JJ		
E	 grå	E	KK	 blå	KK		
F	 blå	F	LL	 orange	LL		
H	 hvid	H	MM	 blå	MM		
J	 orange	J	MM	 grøn	MM		
K	 grøn	K	NN	 blå	NN		
L	 orange	L	NN	 brun	NN		
M	 brun	M	PP	 sort	PP		
N	 orange	N	PP	 grøn	PP		
P	 grå	P	RR	 sort	RR		
R	 orange	R	RR	 blå	RR		
S	 grøn	S	RR	 sort	RR		
T	 hvid	T	RR	 orange	RR		
U	 grøn	U	SS	skærm	SS		
V	 brun	V	TT	skærm	TT		
W	 grå	W					
X	 grøn	X					
Y	 hvid	Y					
Z	 brun	Z					
AA	 grå	AA					
BB	 brun	BB					
CC	 sort	CC					
DD	 brun	DD					

Connector I: Elco plug 8016-038-000-004

Connector II: Elco plug 8016-038-000-004

Cable : 2x21x0,14mm<sup>2</sup> m. skærm

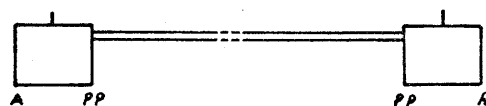

Kabeltype 1 / cm

I		II		I		II	
PIN	WIRE	PIN	PIN	WIRE	PIN	PIN	
A	— rød	A	EE	— lys brun	EE	EE	
B	— rød	B	FF	— lys brun	FF	FF	
C	— rød	C	HH		HH	HH	
D	— orange	D	JJ		JJ	JJ	
E	— orange	E	KK		KK	KK	
F	— gul	F	LL		LL	LL	
H		H	MM	skærm	MM	MM	
J		J	NN	skærm	NN	NN	
K		K	PP	— hvid	PP	PP	
L	— violet	L	RR	— grå	RR	RR	
M	— violet	M	SS	— grå	SS	SS	
N	— lys rød	N	TT	— hvid	TT	TT	
P	— lys rød	P					
R	— grøn	R					
S	— grøn	S					
T	— blå	T					
U	— blå	U					
V		V					
W		W					
X		X					
Y		Y					
Z		Z					
AA	— sort	AA					
BB	— sort	BB					
CC	— brun	CC					
DD	— brun	DD					

Connector I : Elco plug 8016-038-000-004

Connector II: Elco plug 8016-038-000-004

Cable : 24 x 0,40mm<sup>2</sup>. skærm

Kabeltype 2 / cm

V20717

Connector I: Amphenol MS 3108 B-14S insert 7P  
Connector II: Amphenol MS 3108 B-14S insert 7S  
Cable: 2x0,75mm<sup>2</sup> m. skærm

I PIN	WIRE	II PIN
A	— rød	A
C	— grå	C
B	skærm	B

Kabeltype 3. cm



























































































Connector I : Amphenol MS 3108B - 14S insert 7P  
 Connector II : Amphenol MS 3108B - 14S insert 7S  
 Cable : 4x0,75mm<sup>2</sup> med skærm

I		II
PIN	WIRE	PIN
A	— rød	A
A	— gul	A
C	— hvid	C
C	— grå	C
B	skærm	B

Connector I: Elco plug 8016-090-704

Connector II: Elco plug 8016-090-704

Cable : Type HKP - S - K, 43x2x0,20mm<sup>2</sup> + 4x0,30mm<sup>2</sup> + skærm

I		II		I		II		I		II	
PIN	WIRE	PIN	PIN	WIRE	PIN	PIN	WIRE	PIN	PIN	WIRE	PIN
A	 sort	A	AM	 grøn	AM	BY	 grøn	BY			BY
B	 blå	B	AN	 grå	AN	BZ	 violet	BZ			BZ
C	 sort	C	AP	 brun	AP	CA	 rød	CA			CA
D	 orange	D	AR	 hvid	AR	CB	 grå	CB			CB
E	 sort	E	AS	 brun	AS	CC	 rød	CC			CC
F	 grøn	F	AT	 grå	AT	CD	 orange	CD			CD
H	 sort	H	AU	 grå	AU	CE	 rød	CE			CE
J	 brun	J	AV	 hvid	AV	CF	 gul	CF			CF
K	 sort	K	AW	 sort	AW	CH	 rød	CH			CH
L	 grå	L	AX	 hvid	AX	CJ	 brun	CJ			CJ
M	 blå	M	AY	 sort	AY	CK	 rød	CK			CK
N	 hvid	N	AZ	 rød	AZ	CL	 violet	CL			CL
P	 blå	P	BA	 sort	BA	CM	 grå	CM			CM
R	 orange	R	BB	 gul	BB	CN	 gul	CN			CN
S	 blå	S	BC	 sort	BC	CP	 grå	CP			CP
T	 grøn	T	BD	 violet	BD	CR	 violet	CR			CR
U	 blå	U	BE	 hvid	BE	CS	 orange	CS			CS
V	 brun	V	BF	 rød	BF	CT	 gul	CT			CT
W	 blå	W	BH	 hvid	BH	CU	 orange	CU			CU
X	 grå	X	BJ	 gul	BJ	CV	 violet	CV			CV
Y	 orange	Y	BK	 hvid	BK						
Z	 hvid	Z	BL	 violet	BL	CW	 brun	CW			CW
AA	 orange	AA	BM	 blå	BM						
AB	 grøn	AB	BN	 rød	BN	CX	 rød	CX			CX
AC	 orange	AC	BP	 blå	BP						
AD	 brun	AD	BR	 gul	BR	CY	 grøn	CY			CY
AE	 orange	AE	BS	 blå	BS						
AF	 grå	AF	BT	 violet	BT	CZ	 blå	CZ			CZ
AH	 grøn	AH	BU	 grøn	BU						
AJ	 hvid	AJ	BV	 rød	BV	DA	 skærm	DA			DA
AK	 grøn	AK	BW	 grøn	BW						
AL	 brun	AL	BX	 gul	BX	DB	 skærm	DB			DB



































































































Connector I: Elco 8016-090-704

Connector II: Burndy MS 75P-124

Cable : Type HKP-S-K, 43 x 2 x 0,20 mm<sup>2</sup> + 4 x 0,50 mm<sup>2</sup> + skærm

I			II			I			II			
PIN		WIRE	PIN	PIN	WIRE	PIN	PIN	WIRE	PIN	PIN	WIRE	PIN
A		sort	01	AM		35	BY		67	grøn		
B		blå	04	AN		38	BZ		72	violet		
C		sort	02	AP		36	CA		73	rød		
D		orange	05	AR		39	CB		76	grå		
E		sort	03	AS		40	CC		74	rød		
F		grøn	07	AT		43	CD		77	orange		
H		sort	08	AU		41	CE		75	rød		
J		brun	12	AV		44	CF		78	gul		
K		sort	10	AW		42	CH		80	rød		
L		grå	13	AX		45	CJ		79	brun		
M		blå	11	AY		46	CK		81	rød		
N		hvid	14	AZ		49	CL			violet		
P		blå	15	BA		47	CM			grå		
R		orange	18	BB		50	CN			gul		
S		blå	16	BC		48	CP			grå		
T		grøn	20	BD		51	CR			violet		
U		blå	17	BE		52	CS			orange		
V		brun	21	BF		55	CT			gul		
W		blå	22	BH		53	CU			orange		
X		grå	25	BJ		56	CV			violet		
Y		orange	23	BK		54						
Z		hvid	26	BL		57	CW			brun		
AA		orange	24	BM		58						
AB		grøn	27	BN		62	CX			rød		
AC		orange	28	BP		59						
AD		brun	31	BR		63	CY			grøn		
AE		orange	29	BS		60						
AF		grå	32	BT		64	CZ			blå		
AH		grøn	30	BU		65						
AJ		hvid	33	BV		70	DA			skærm		
AK		grøn	34	BW		66						
AL		brun	37	BX		71	DB			skærm		













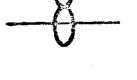
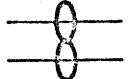
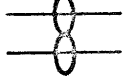
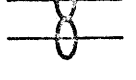
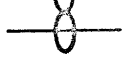

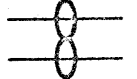
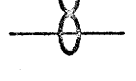
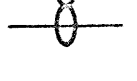
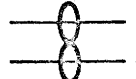

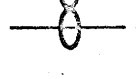
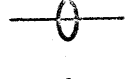

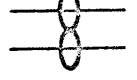
Connector I : Elco plug 8016-090-704  
 Connector II: Elco plug 8016-090-704  
 Cable : Datwyler type 2783, 50x2x0,25 mm<sup>2</sup>

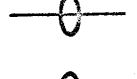
I		II		I		II		I		II	
PIN	WIRE	PIN	PIN	WIRE	PIN	PIN	WIRE	PIN	PIN	WIRE	PIN
A	 hvid	A	AM	 hvid	AM	BY	 hvid	BY			BY
B	 blå	B	AN	 grøn/grø	AN	BZ	 gul/brun/rød	BZ			BZ
C	 hvid	C	AP	 hvid	AP	CA	 hvid	CA			CA
D	 gul	D	AR	 brun/hvid	AR	CB	 gul/grø/rød	CB			CB
E	 hvid	E	AS	 hvid	AS	CC	 hvid	CC			CC
F	 grøn	F	AT	 brun/grø	AT	CD	 grøn/hvid/rød	CD			CD
H	 hvid	H	AU	 hvid	AU	CE	 hvid	CE			CE
J	 brun	J	AV	 grø/hvid	AV	CF	 grøn/brun/rød	CF			CF
K	 hvid	K	AW	 hvid	AW	CH	 hvid	CH			CH
L	 grø	L	AX	 blå/rød	AX	CJ	 grøn/grø/rød	CJ			CJ
M	 hvid	M	AY	 hvid	AY	CK	 hvid	CK			CK
N	 blå/hvid	N	AZ	 gul/rød	AZ	CL	 brun/hvid/rød	CL			CL
P	 hvid	P	BA	 hvid	BA	CM	 hvid	CM			CM
R	 blå/gul	R	BB	 grøn/rød	BB	CN	 brun/grø/rød	CN			CN
S	 hvid	S	BC	 hvid	BC	CP	 hvid	CP			CP
T	 blå/grøn	T	BD	 brun/rød	BD	CR	 grø/hvid/rød	CR			CR
U	 hvid	U	BE	 hvid	BE	CS	 rød	CS			CS
V	 blå/brun	V	BF	 grø/rød	BF	CT	 blå	CT			CT
W	 hvid	W	BH	 hvid	BH	CU	 rød	CU			CU
X	 blå/grø	X	BJ	 blå/hvid/rød	BJ	CV	 gul	CV			CV
Y	 hvid	Y	BK	 hvid	BK	CW	 rød	CW			CW
Z	 gul/hvid	Z	BL	 blå/gul/rød	BL	CW	 grøn	CW			CW
AA	 hvid	AA	BM	 hvid	BM	CX	 rød	CX			CX
AB	 gul/grøn	AB	BN	 blå/grøn/rød	BN	CX	 brun	CX			CX
AC	 hvid	AC	BP	 hvid	BP	CY	 rød	CY			CY
AD	 gul/brun	AD	BR	 blå/brun/rød	BR	CY	 grø	CY			CY
AE	 hvid	AE	BS	 hvid	BS	CZ	 rød	CZ			CZ
AF	 gul/grø	AF	BT	 blå/grø/rød	BT	CZ	 blå/hvid	CZ			CZ
AH	 hvid	AH	BU	 hvid	BU	DA	 rød	DA			DA
AJ	 grøn/hvid	AJ	BV	 gul/hvid/rød	BV	DA	 blå/gul	DA			DA
AK	 hvid	AK	BW	 hvid	BW	DB	 rød	DB			DB
AL	 grøn/brun	AL	BX	 gul/grøn/rød	BX	DB	 blå/grøn	DB			DB

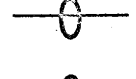
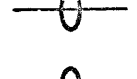
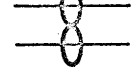
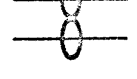
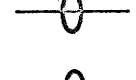
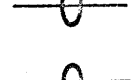
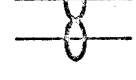
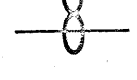
Designed by 080868JAK  
 Drawn by 080868AL  
 Dwg.-Office Check  
 Design Check  
 Replaces Dwg. No.  
 due to ECN  
 Registered by Dwg. No.

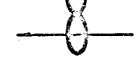
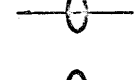
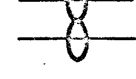
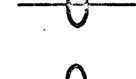
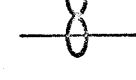
Connector I: Elco plug 8016-090-704 uden kappe  
 Connector II: Elco plug 8016-090-704 uden kappe  
 Wire : Snoet Litze PFR, 2x0,22 mm<sup>2</sup>.

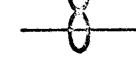
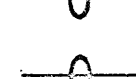
I			II			I			II		
PIN		WIRE	PIN	PIN		WIRE	PIN	PIN		WIRE	PIN
A		rød	A	AM		rød	AM	BY		rød	BY
B		blå	B	AN		blå	AN	BZ		blå	BZ
C		rød	C	AP		rød	AP	CA		rød	CA
D		blå	D	AR		blå	AR	CB		blå	CB
E		rød	E	AS		rød	AS	CC		rød	CC
F		blå	F	AT		blå	AT	CD		blå	CD
H		rød	H	AU		rød	AU	CE		rød	CE
J		blå	J	AV		blå	AV	CF		blå	CF
K		rød	K	AW		rød	AW	CH		rød	CH
L		blå	L	AX		blå	AX	CJ		blå	CJ
M		rød	M	AY		rød	AY	CK		rød	CK
N		blå	N	AZ		blå	AZ	CL		blå	CL
P		rød	P	BA		rød	BA	CM		rød	CM
R		blå	R	BB		blå	BB	CN		blå	CN
S		rød	S	BC		rød	BC	CP		rød	CP
T		blå	T	BD		blå	BD	CR		blå	CR
U		rød	U	BE		rød	BE	CS		rød	CS
V		blå	V	BF		blå	BF	CT		blå	CT
W		rød	W	BH		rød	BH	CU		rød	CU
X		blå	X	BJ		blå	BJ	CV		blå	CV
Y		rød	Y	BK		rød	BK	CW		rød	CW
Z		blå	Z	BL		blå	BL	CW		blå	CW
AA		rød	AA	BM		rød	BM	CX		rød	CX
AB		blå	AB	BN		blå	BN	CX		blå	CX
AC		rød	AC	BP		rød	BP	CY		rød	CY
AD		blå	AD	BR		blå	BR	CY		blå	CY
AE		rød	AE	BS		rød	BS	CZ		rød	CZ
AF		blå	AF	BT		blå	BT	CZ		blå	CZ
AH		rød	AH	BU		rød	BU	DA		rød	DA
AJ		blå	AJ	BV		blå	BV	DA		blå	DA
AK		rød	AK	BW		rød	BW	DB		rød	DB
AL		blå	AL	BX		blå	BX	DB		blå	DB

I PIN	WIRE	II PIN	I PIN	WIRE	II PIN
A	 hvid	2	EE	 grå	
B	 grå	15	FF	 sort	
C	 hvid	1	HH	 blå	
D	 sort	15	JJ	 hvid	
E	 grå	3	KK	 blå	
F	 blå	15	LL	 orange	
H	 hvid	4	MM	 blå	
J	 orange	15	MM	 grøn	
K	 grøn	9	NN	 blå	19
L	 orange	15	NN	 brun	19
M	 brun	10	PP	 sort	19
N	 orange	15	PP	 grøn	19
P	 grå	12	RR	 sort	19
R	 orange	13	RR	 blå	19
S	 grøn	7	RR	 sort	19
T	 hvid	13	RR	 orange	19
U	 grøn	8	SS	skærm	
V	 brun	13	TT	skærm	
W	 grå	11			
X	 grøn	6			
Y	 hvid				
Z	 brun				
AA	 grå	16			
BB	 brun	19			
CC	 sort	5			
DD	 brun	19			

PIN 15 og PIN 19 forbindes internt i stikket.

Connector I: Elco plug 8016-038-000-004

Connector II: Cannon multi plug SK-19-21C-1/2











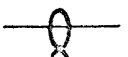

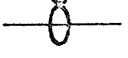
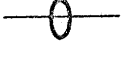

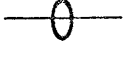
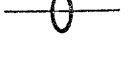

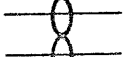
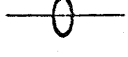
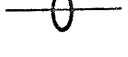
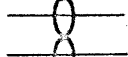
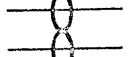
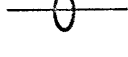
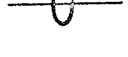

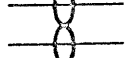
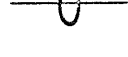

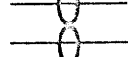
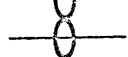

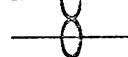
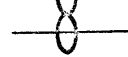

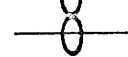
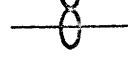

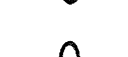
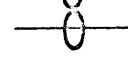
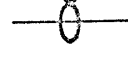
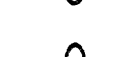
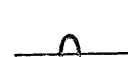

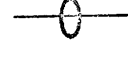

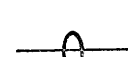
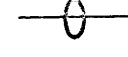
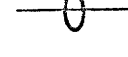
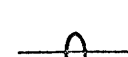

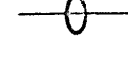

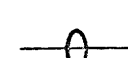
Cable: 2x21x0,14mm<sup>2</sup> med skærm

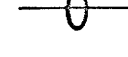
Kabeltype 9/ cm.

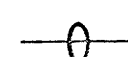
Connector I : ELCO 8016 - 056 - 000 - 004

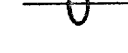
Connector II : ELCO 8016 - 056 - 000 - 004

Cable :  $25 \times 2 \times 0,14 \text{ mm}^2 + 4 \times 0,50 \text{ mm}^2 + \text{skærm}$

I		II		I		II	
PIN	WIRE	PIN	PIN	WIRE	PIN	PIN	
A	 sort	A	h	 grøn	h		
B	 blå	B	i	 hvid	i		
C	 sort	C	k	 grøn	k		
D	 orange	D	l	 brun	l		
E	 sort	E	m	 grøn	m		
F	 grøn	F	n	 grå	n		
H	 sort	H	p	 brun	p		
J	 brun	J	r	 hvid	r		
K	 sort	K	s	 brun	s		
L	 grå	L	t	 grå	t		
M	 blå	M	u	 grå	u		
N	 hvid	N	v	 hvid	v		
P	 blå	P	w	 sort	w		
R	 orange	R	x	 hvid	x		
S	 blå	S	y	 sort	y		
T	 grøn	T	z	 rød	z		
U	 blå	U	AA	 sort	AA		
V	 brun	V	BB	 gul	BB		
W	 blå	W	CC	 sort	CC		
X	 grå	X	DD	 violet	DD		
Y	 orange	Y	EE	 hvid	EE		
Z	 hvid	Z	FF	 rød	FF		
a	 orange	a	HH	 rød	HH		
b	 grøn	b	JJ	 blå	JJ		
c	 orange	c	KK	 brun	KK		
d	 brun	d	LL	 grøn	LL		
e	 orange	e	MM	 skærm	MM		
f	 grå	f	NN	 skærm	NN		

Kabeltype 10/ cm

Connector I: Amphenol MS 3108 3-14 S insert 7P

































































































Connector II: Hubbell twist-lock no. 7484 cap

Cable:  $2 \times 0,75 \text{ mm}^2$  m. skærm

I		II
PIN	WIRE	PIN
A	— rød	X
C	— grå	Y
B	skærm	W

Kabeltype 11/ cm

Connector I: Elco plug 8016-090-704  
 Connector II: Burndy MS75P-124  
 Cable: Datwyler type 2783, 50x2x0,25mm<sup>2</sup>

I			II			I			II		
PIN	WIRE		PIN	PIN	WIRE	PIN	PIN	WIRE	PIN	PIN	WIRE
A	 hvid		1	AM	 hvid	35	BY	 hvid			
B	 blå		4	AN	 grøn/grå	38	BZ	 gul/brun/rød			
C	 hvid		2	AP	 hvid	36	CA	 hvid			
D	 gul		5	AR	 brun/hvid	39	CB	 gul/grå/rød			
E	 hvid		3	AS	 hvid	40	CC	 hvid			
F	 grøn		7	AT	 brun/grå	43	CD	 grøn/hvid/rød			
H	 hvid		8	AU	 hvid	41	CE	 hvid			
J	 brun		12	AV	 grå/hvid	44	CF	 grøn/brun/rød			
K	 hvid		10	AW	 hvid	42	CH	 hvid			
L	 grå		13	AX	 blå/rød	45	CI	 grøn/grå/rød			
M	 hvid		11	AY	 hvid	46	CK	 hvid			
N	 blå/hvid		14	AZ	 gul/rød	49	CL	 brun/hvid/rød			
P	 hvid		15	BA	 hvid	47	CM	 hvid			
R	 blå/gul		18	BB	 grøn/rød	50	CN	 brun/grå/rød			
S	 hvid		16	BC	 hvid	48	CP	 hvid			
T	 blå/grøn		20	BD	 brun/rød	51	CR	 grå/hvid/rød			
U	 hvid		17	BE	 hvid	52	CS	 rød			
V	 blå/brun		21	BF	 grå/rød	55	CT	 blå			
W	 hvid		22	BH	 hvid	53	CU	 rød			
X	 blå/grå		25	BJ	 blå/hvid/rød	56	CV	 gul			
Y	 hvid		23	BK	 hvid	54	CW	 rød			
Z	 gul/hvid		26	BL	 blå/gul/rød	57	CX	 grøn			
AA	 hvid		24	BM	 hvid	58	CX	 rød			
AB	 gul/grøn		27	BN	 blå/grøn/rød	62	CX	 brun			
AC	 hvid		28	BP	 hvid	59	CY	 rød			
AD	 gul/brun		31	BR	 blå/brun/rød	63	CY	 grå			
AE	 hvid		29	BS	 hvid		CZ	 rød			
AF	 gul/grå		32	BT	 blå/grå/rød		CZ	 blå/hvid			
AH	 hvid		30	BU	 hvid		DA	 rød			
AJ	 grøn/hvid		33	BV	 gul/hvid/rød		DA	 blå/gul			
AK	 hvid		34	BW	 hvid		DB	 rød			
AL	 grøn/brun		37	BX	 gul/grøn/rød		DB	 blå/grøn			

Bemærk! De overskydende ledninger i Burndy stikket klippes af umiddelbart for kappen afsluttes, således at de afklippede ledninger ikke kommer i berøring med metalrøven om Burndy stikket.

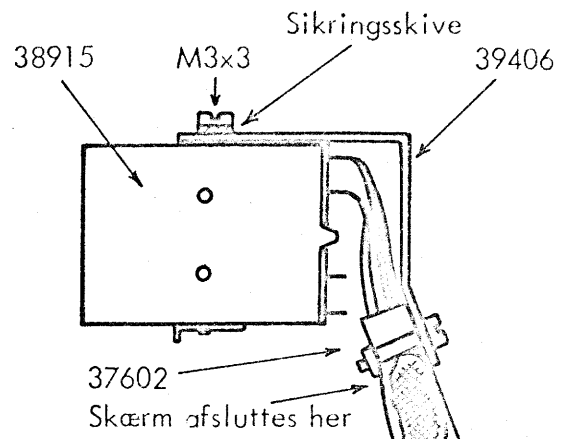
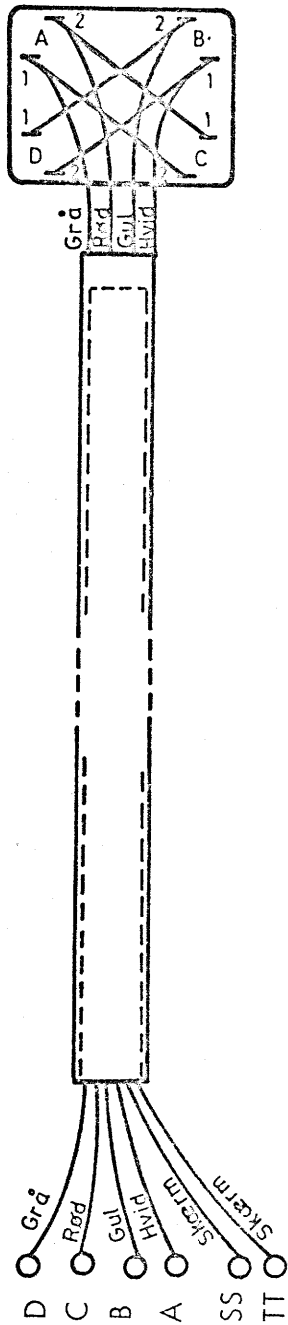

Kabel 4 x 0,75 mm<sup>2</sup> m/skærm

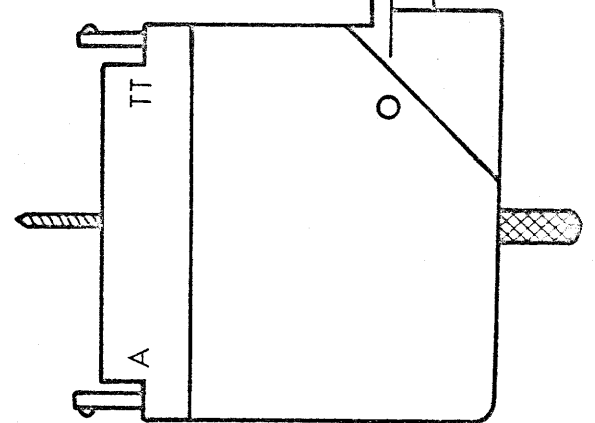

Elco plug 8016-038-000-004

Kabeltype 13/

cm



I			II			II		
PIN		WIRE	PIN	PIN	WIRE	PIN		
A		hvid	A	EE		EE		
B		grå	B	FF		FF		
C		hvid	C	HH		HH		
D		sort	D	JJ		JJ		
E		grå	E	KK		KK		
F		blå	F	LL		LL		
H		hvid	H	MM		MM		
J		orange	J	MM		MM		
K		grøn	K	NN		NN		
L		orange	L	NN		NN		
M		brun	M	PP		PP		
N		orange	N	PP		PP		
P		grå	P	RR		RR		
R		orange	R	RR		RR		
S		grøn	S	RR		RR		
T		hvid	T	RR		RR		
U		grøn	U	SS		SS		
V		brun	V	TT	skærm	TT		
W		grå	W					
X		grøn	X					
Y		hvid	Y					
Z		brun	Z					
AA		grå	AA					
BB		brun	BB					
CC		sort	CC					
DD		brun	DD					

Connector I: Elco plug 8016-038-000-004  
 Connector II: Elco plug 8016-038-000-003  
 Cable : 2x21x0,14mm<sup>2</sup> m.skærm

Kabeltype 14/ cm

Connector I: Amphenol MS 310B3-14S insert 7P  
Connector II: Amphenol MS 3106A-14S insert 7S  
Cable: 2x0,75mm<sup>2</sup> m. skærm

I		II
PIN	WIRE	PIN
A	— rod	A
C	— grå	C
B	skærm	B

Elco plug  
8016-038-000-004

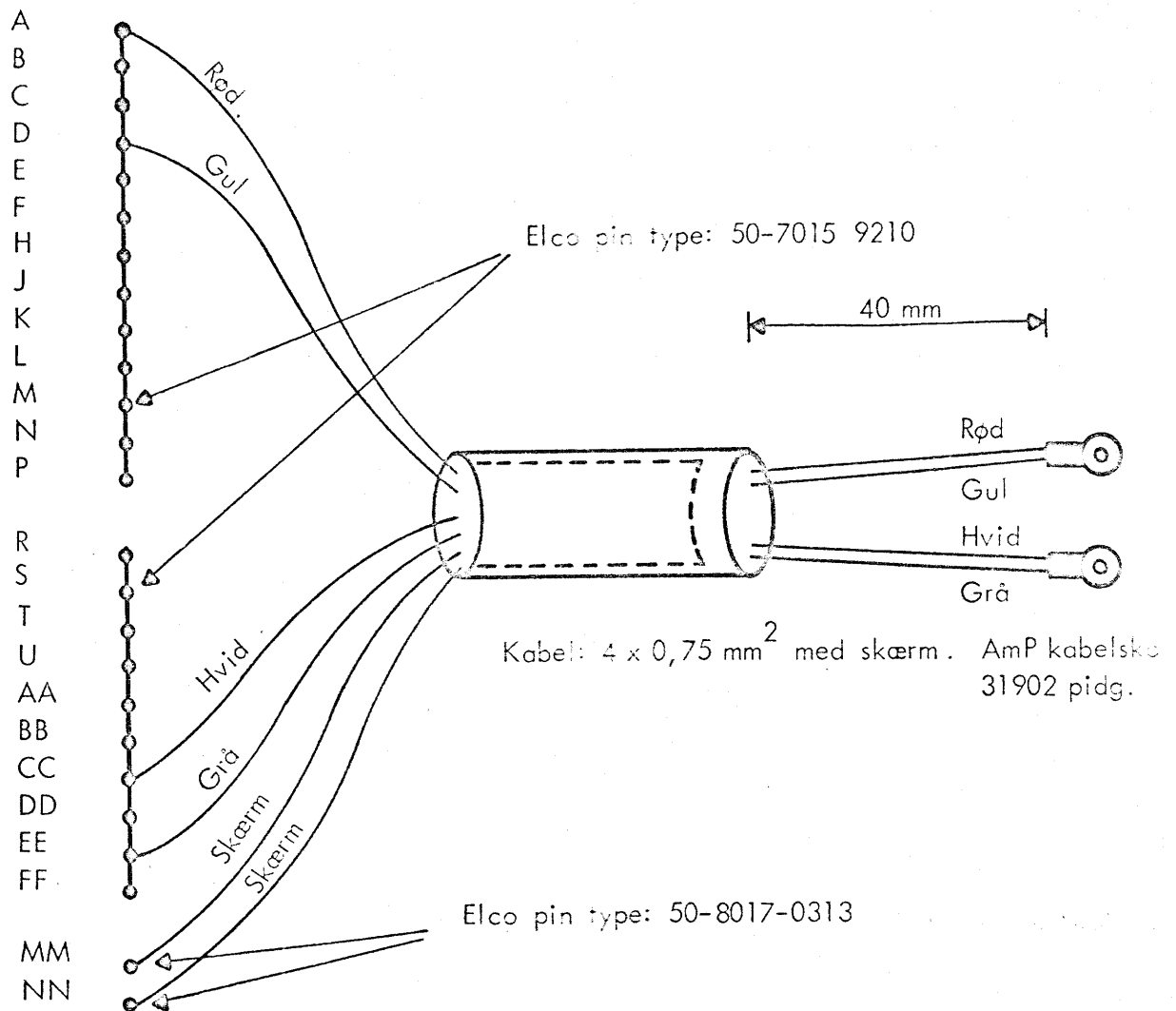

Connector I: AMP kabelsko 130171 (2,7-6,6)

Connector II: AMP kabelsko 130171 (2,7-6,6)

Cable : NKT ledning 6 mm<sup>2</sup>

Connector I : AMP kabelsko 160057 (10-16)

Connector II: AMP kabelsko 160057 (10-16)

Cable : NEK ledning, type PKL 16 mm<sup>2</sup>

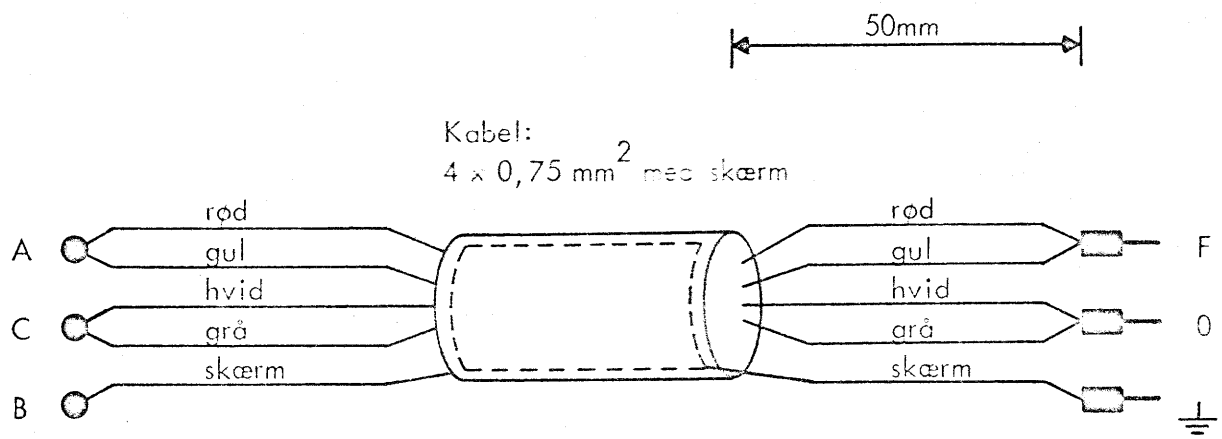

Amphenol  
MS 3108B - 14S insert 7S

AMP  
Wire pins 165046

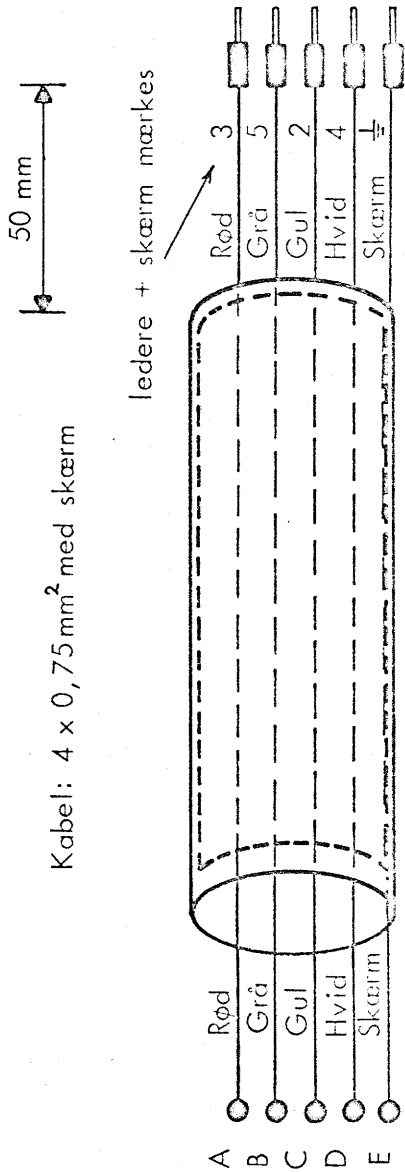

Amphenol M53106A-145 innet 55

AMP Wire pins 165142

100 E 1/8W

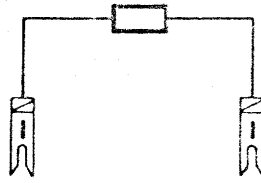

Elco crimp 8017-0313

Monteres i

Elco receptacle 8016-090-704

A	B
C	D
E	F
H	J
K	L
M	N
P	R
S	T
U	V
W	X
Y	Z
AA	AB
AC	AD
AE	AF
AH	AJ
AK	AL
AM	AN
AP	AR
AS	AT
AU	AV
AW	AX
AY	AZ
BA	BB
BC	BD
BE	BF
BH	BJ
BK	BL
BM	BN
BP	BR
BS	BT
BU	BV
BW	BX
BY	BZ
CA	CB
CC	CD
CE	CF
CH	CJ
CK	CL
CM	CN
CP	CR
CS	CT
CU	CV



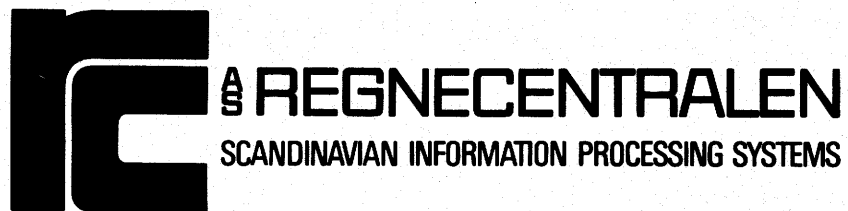

**REGNECENTRALEN**

**SCANDINAVIAN INFORMATION PROCESSING SYSTEMS**

FALKONERALLE 1 · DK 2000 COPENHAGEN F  
DENMARK — TELEPHONE: (01) 10 53 66  
CABLES: REGNECENTRALEN · TELEX: 6282 RC HQ DK