

Title:

DRAWINGS FOR
BCU 801

 A REGNECENTRALEN

RC SYSTEM LIBRARY: FALKONERALLE 1 DK-2000 COPENHAGEN F

RCSL No: 30-M34

Edition: 76.11.24.

Author: Aage Jørgensen

Keywords:

RC8000, Drawings, Bus Control Unit.

Abstract:

This manual contains drawings of BCU801, Bus Control Unit.

Logic Diagrams.

BUS LINE TERMINATIONS	R 11474
BUS LINE TERMINATIONS LINE RECEIVERS FOR BUS CONTROL SIGNAL	R 11475
BUS MASTER SELECTION CONTROL	R 11476
BUS MASTER SELECTION TIME-OUT CONTROL	R 11477
STATUS INDICATORS FOR BUS CONTROL SIGNALS	R 11478
STATUS INDICATORS FOR BUS CONTROL SIGNALS	R 11479
STATUS INDICATORS FOR BUS CONTROL SIGNALS	R 11480

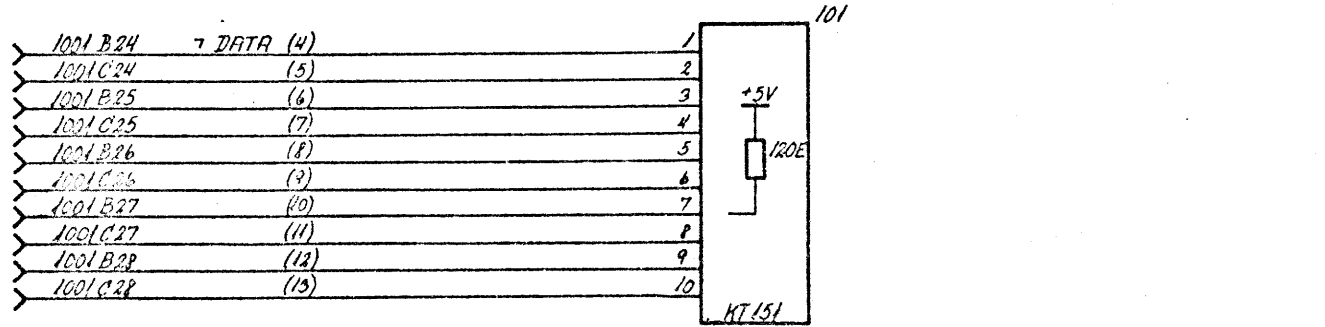
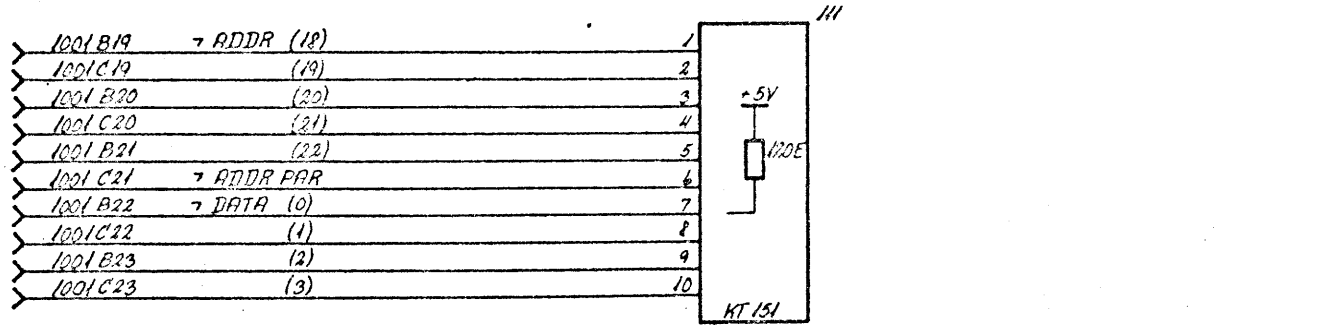
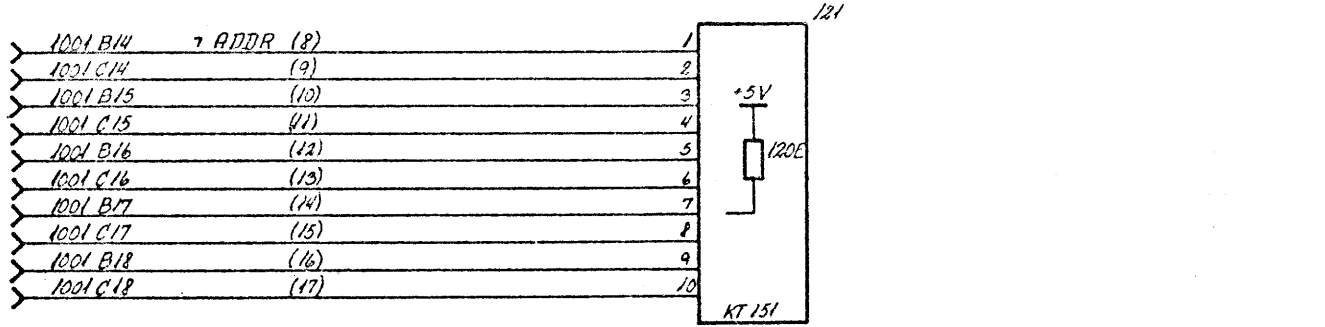
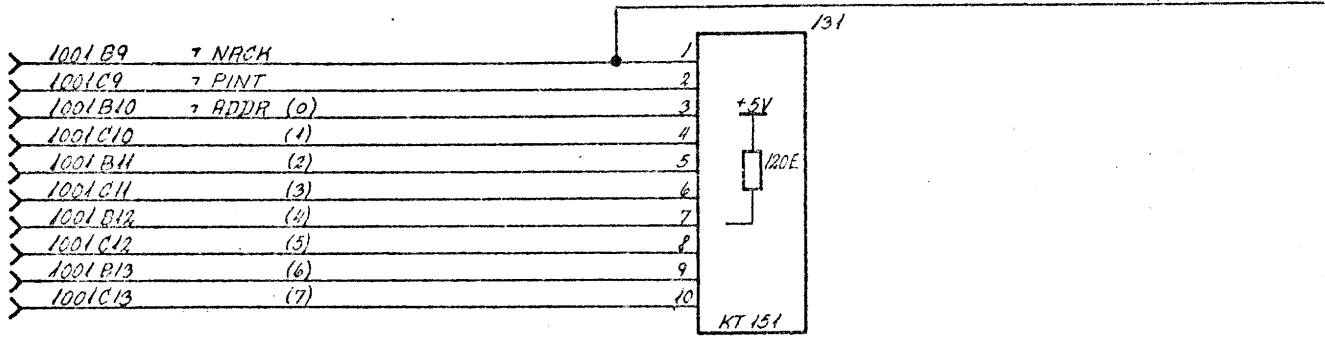
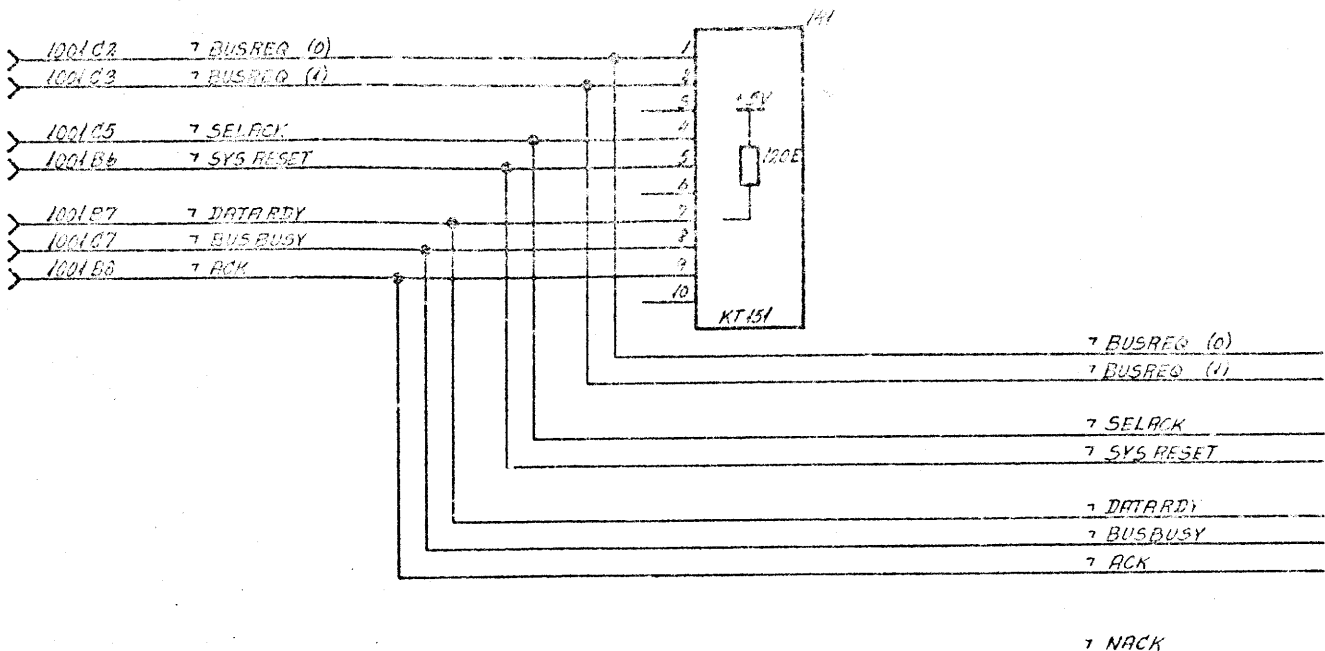

750126 RA7 750103 A2B

BCU 801

BUS LINE TERMINATIONS

R 11474

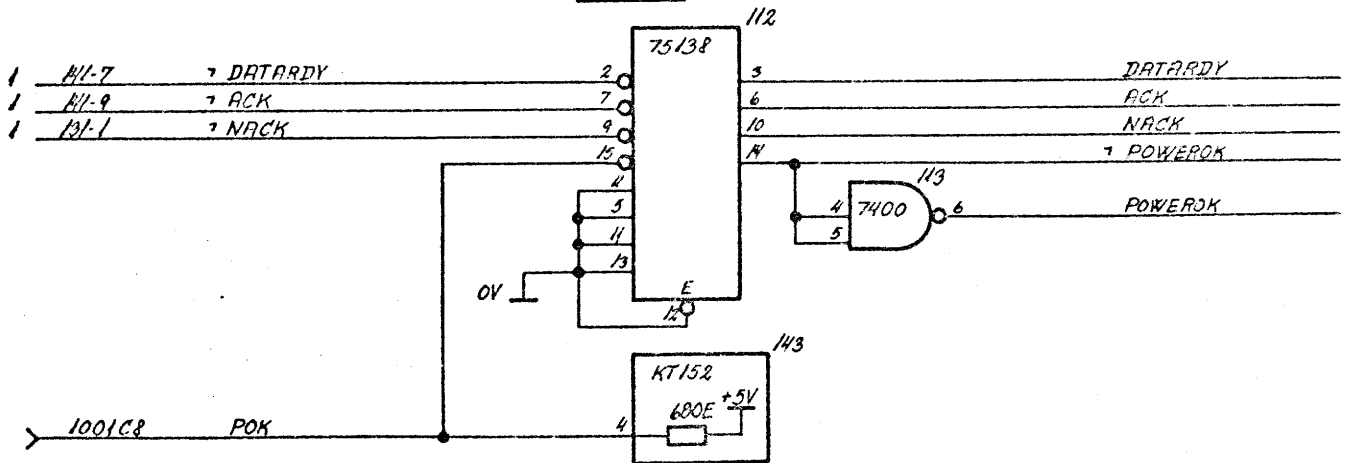
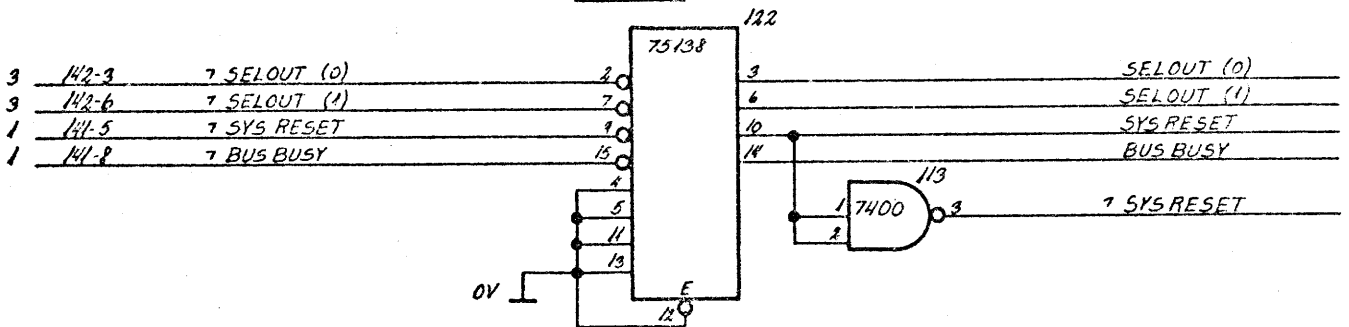
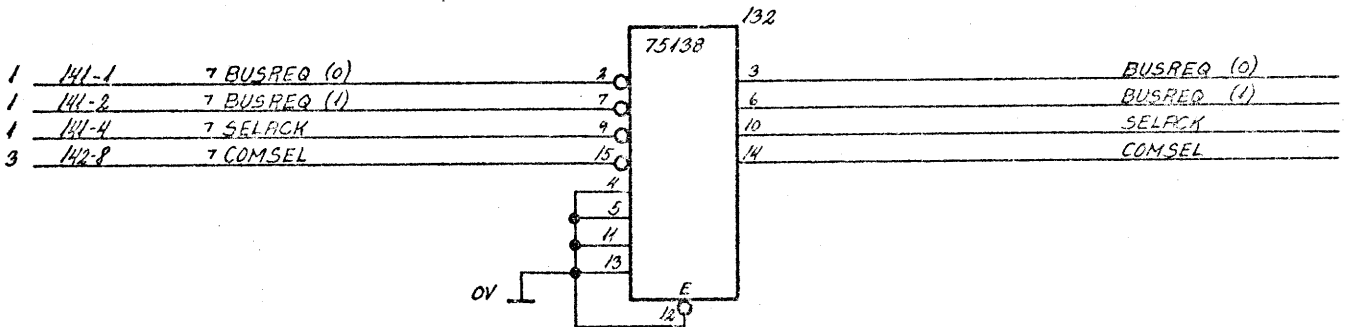
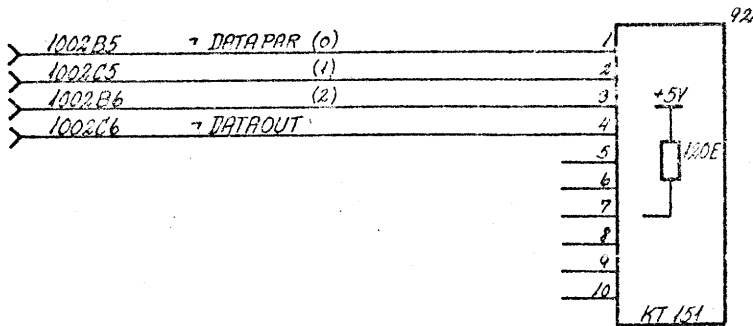
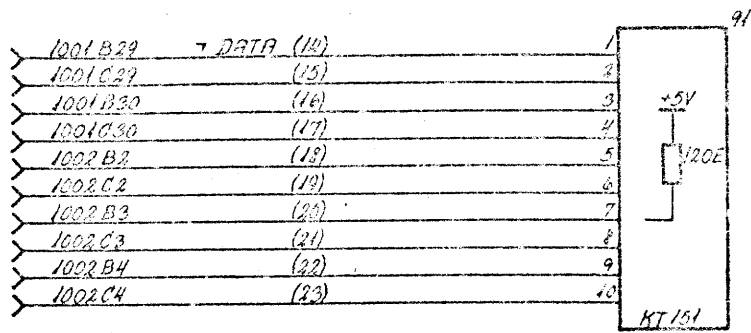

750224 A93 750903 A0B

BCU 801

R 11475

BUS LINE TERMINATIONS
LINE RECEIVERS FOR BUS CONTROL SIGNALS

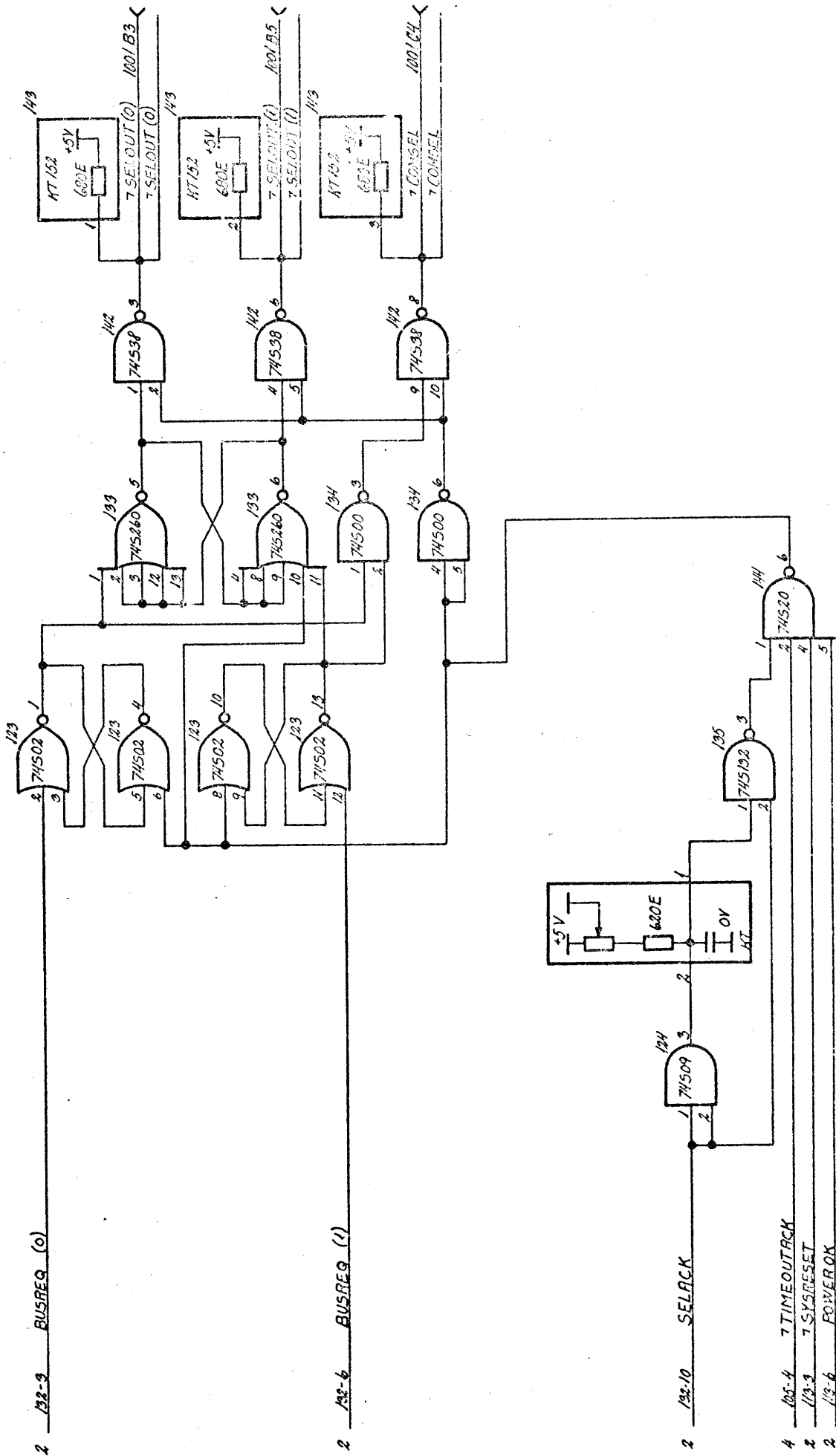

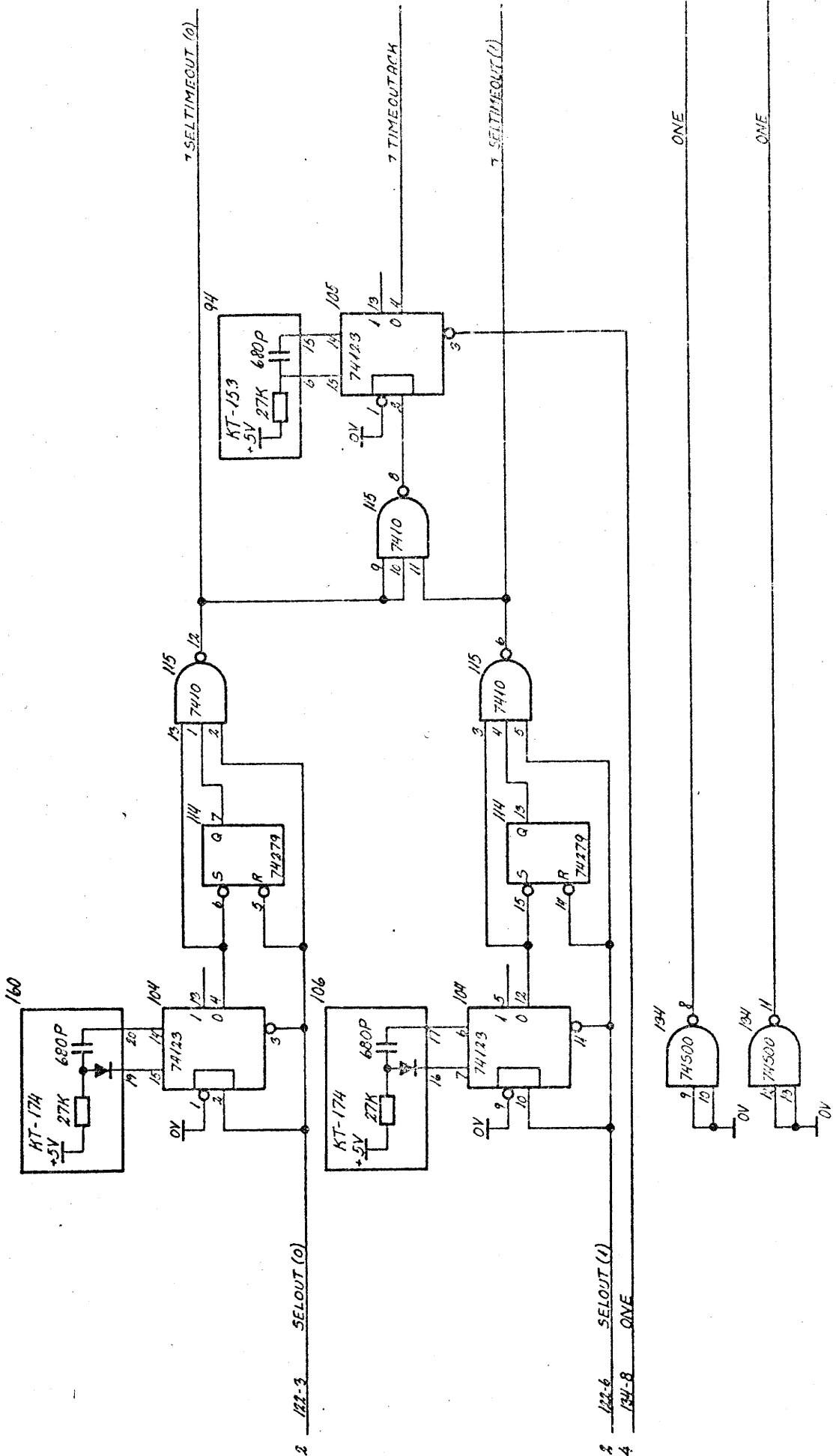

BCU80M
R11477

BUS MASTER SELECTION TIME-OUT CONTROL

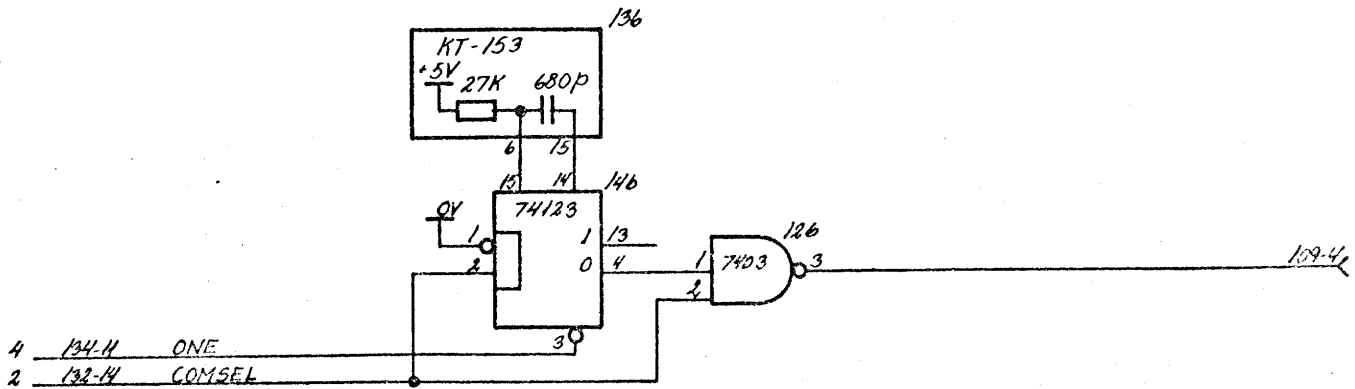
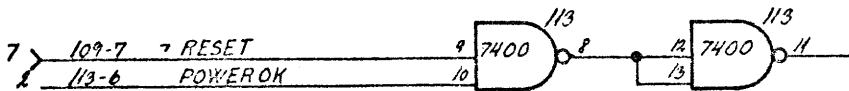
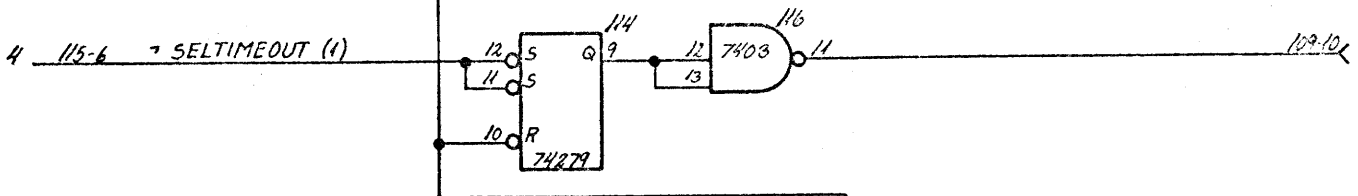
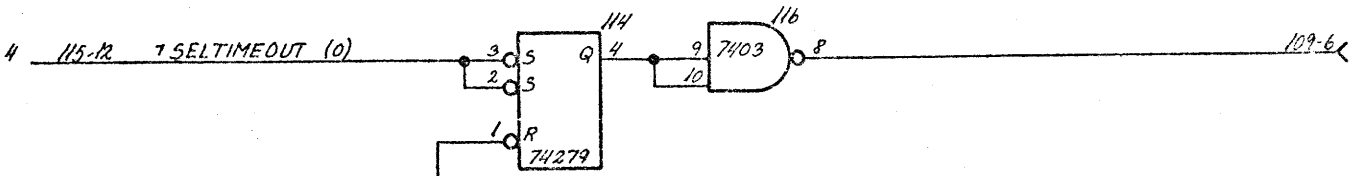
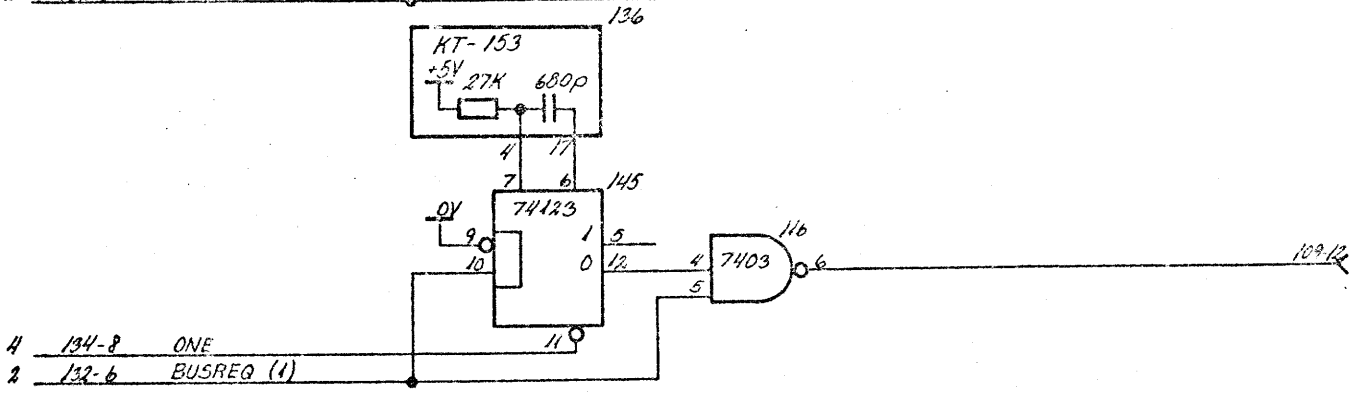
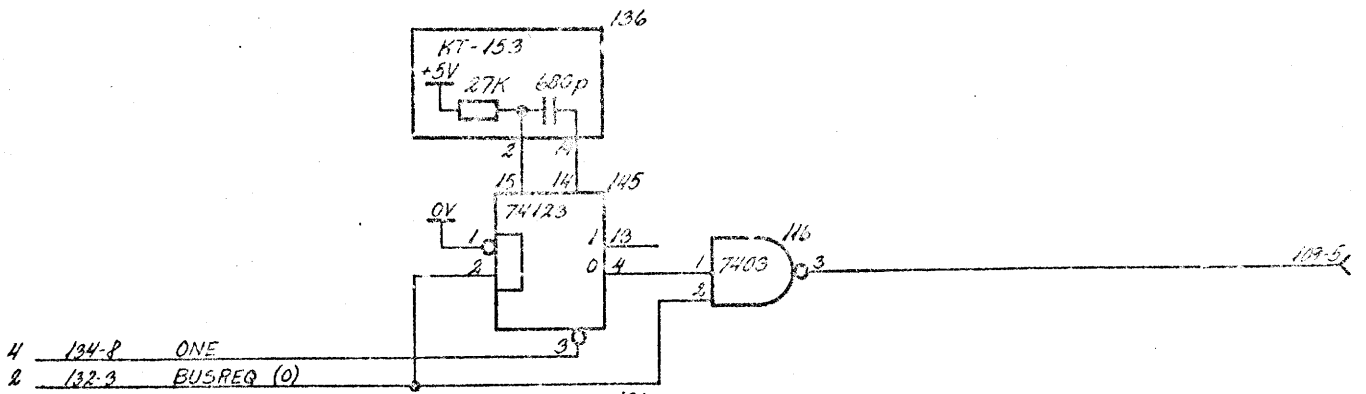

750R26 A07 750R03 A08

760525 AM7 760528 A08

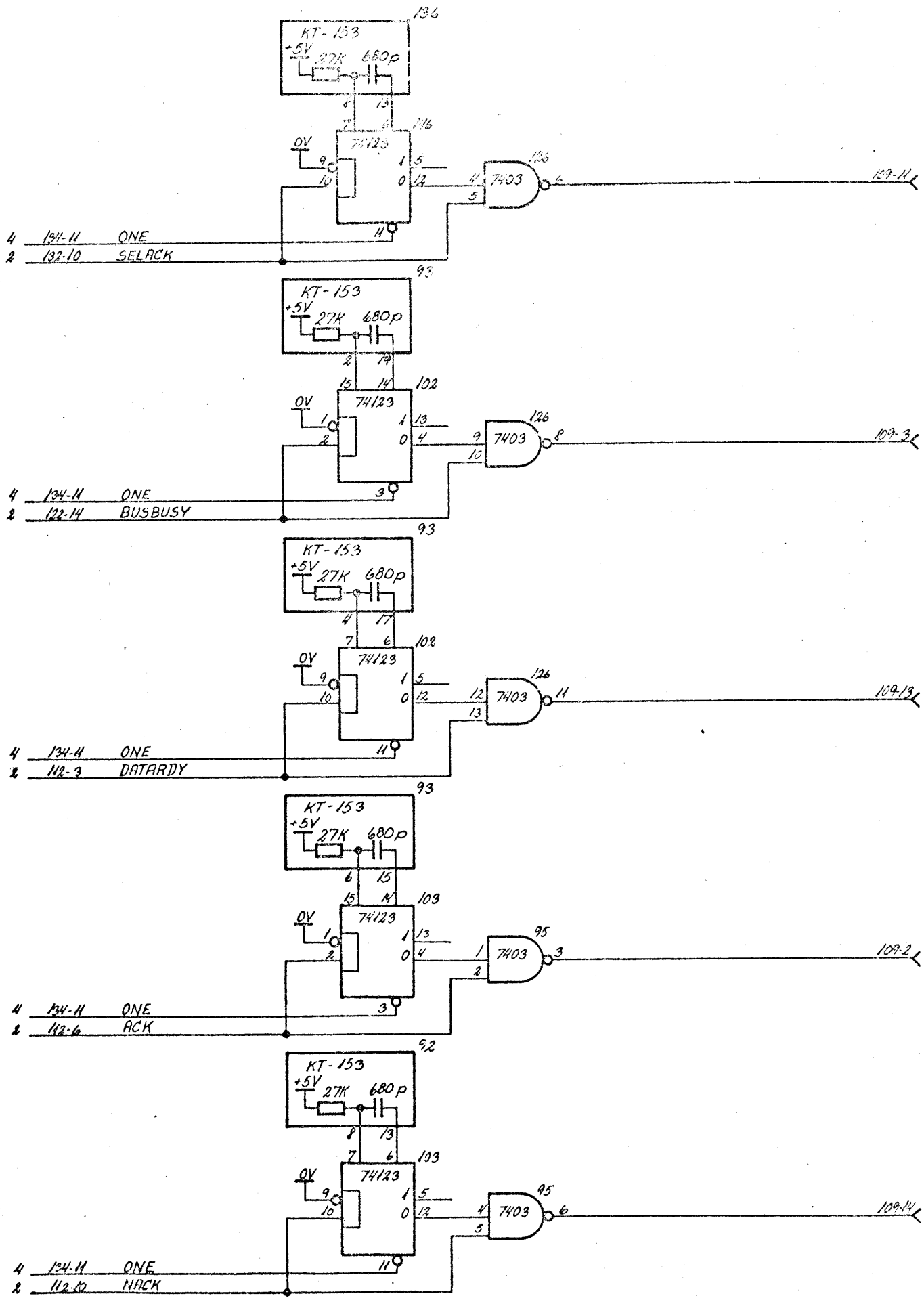

BCU801

STATUS INDICATORS FOR BUS CONTROL SIGNALS

R11479

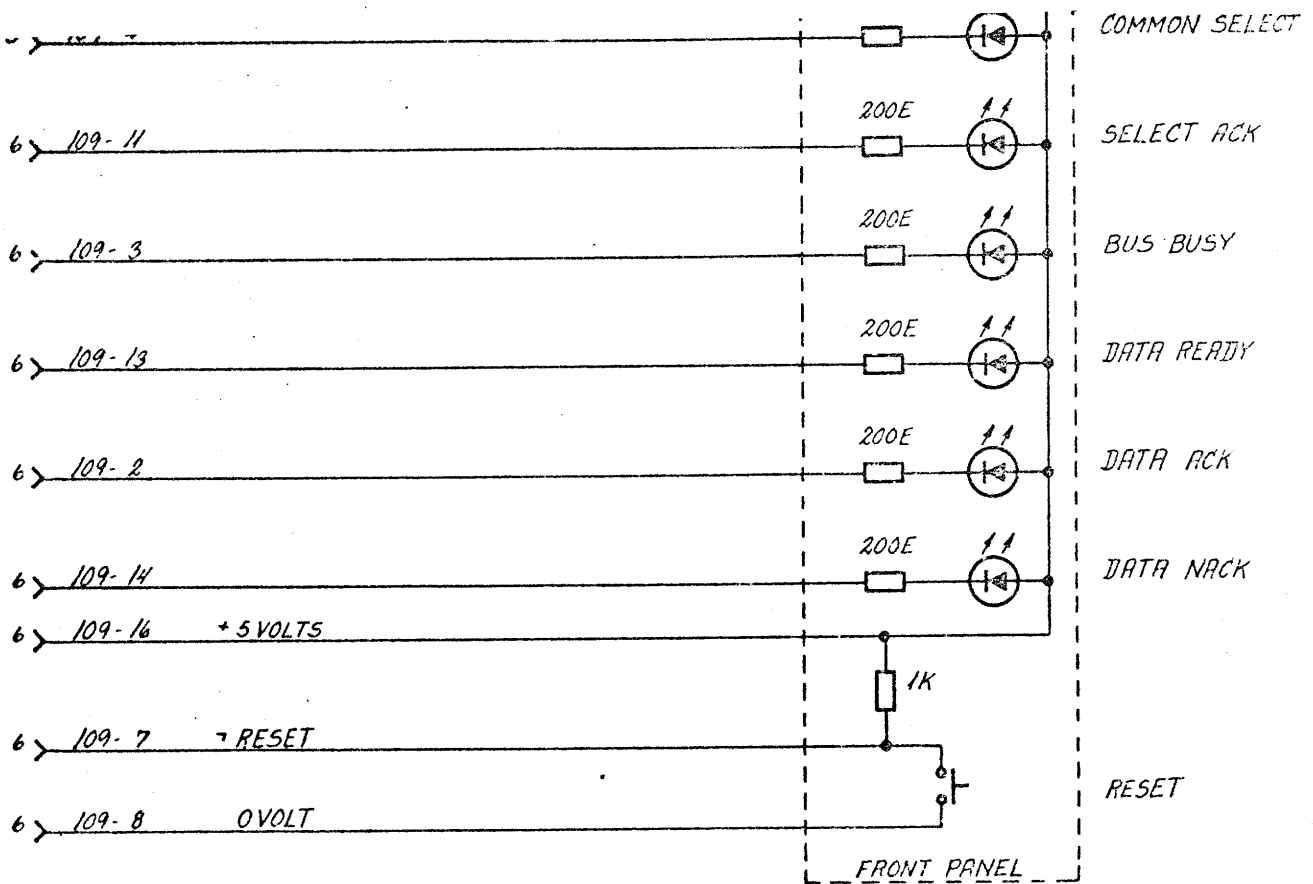

760525 R17 760528 R03

BCU 801
R 11480

STATUS INDICATORS FOR BUS CONTROL SIGNALS