

Index Spare Parts Catalog
RC 2000 Paper Tape Reader

RC Standard Blades	1-9
Cabinet Complete	10
Base Plate, etc.	11
Basic Frame, Front	12
Fan and Filter Assemblies	13
Door and Front Plates	14
Pressure Lid and Tape Guide Assemblies	15
Push Button Unit	16
Selector Switch Board Assembly	17
Lamp and Photocells	18
Capstan Motor Assembly	19
Mains Switch Assembly	20
Power Supply \leq 2205	21
Control Electronics	22
Power Supply $>$ 2205	24
Card 1200	40
Card 1200-1	41
Card 1201	42
Card 1202	43
Card 1203	44
Card 1205-1	45
Card 1212	46
Card 1213	47
Card 1224	48
Card 1227	49
List of Accessories	99

Colour Codes

Carbon Resistor std.

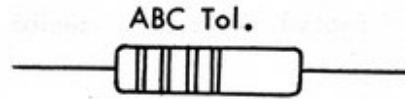

Coloured bands

Ceramic Capacitors std.

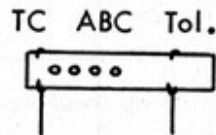

Coloured dots

or

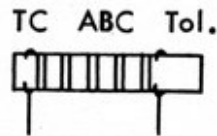

Coloured bands

Polyester Capacitors std.

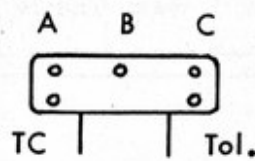

Coloured dots

or

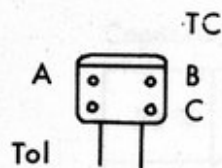

Coloured edge and
Coloured dots

PIN - UP Capacitors std.

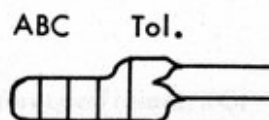

Coloured zones

Colour Codes

The Colour-codes is marked on the resistors and the capacitors as shown on page 7.0. The idea of the colours is as shown below:

The ciffernumbers A and B:

0	1	2	3	4	5	6	7	8	9
black	brown	red	orange	yellow	green	blue	violet	grey	white

The scale factor C:

10^0	10^1	10^2	10^3	10^4	10^5	10^6	10^{-1}	10^{-2}	10^{-1}
black	brown	red	orange	yellow	green	blue	white	grey	gold
ohm/pF							pF		ohm

The tolerance indicator TOL:

Resistors

20%	10%	5%
no colour	silver	gold

Capacitors

20%	10%	5%	2%	1%
black	white	green	red	brown

The indication of temperaturecoefficient TC:

Capacitors

-0×10^{-6}	-150×10^{-6}	-750×10^{-6}
black	orange	violet

SCREWS std.

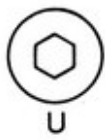

1st Letter

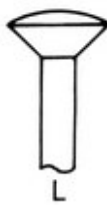
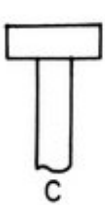
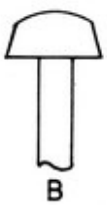
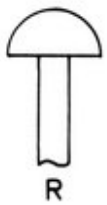

2nd Letter



3rd Letter



4th Letter

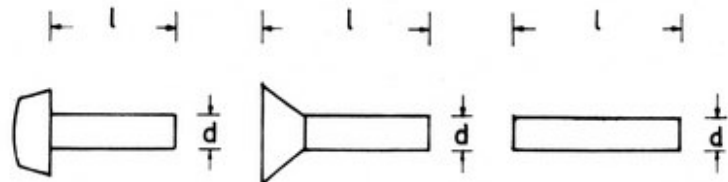

d x l mm

NUTS std.

FLAT WASHERS std.

LOCK WASHERS std.

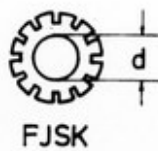
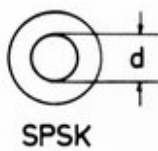
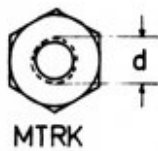

d mm

Standard SCREWS, NUTS and WASHERS

SCREWS, NUTS or WASHERS without REF. No. are RC standard, and can be ordered from the table on page 9.0 as follows:

SCREWS:

(1st letter) (2nd letter) (3rd letter) (4th letter) $d \times l$ mm

Example:

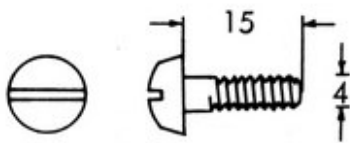

KBNF 4 x 15

NUTS and WASHERS:

(The four letters) d mm

Example:

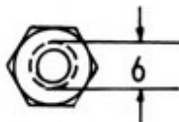

MTRK 6

10.00.00 Cabinet Complete

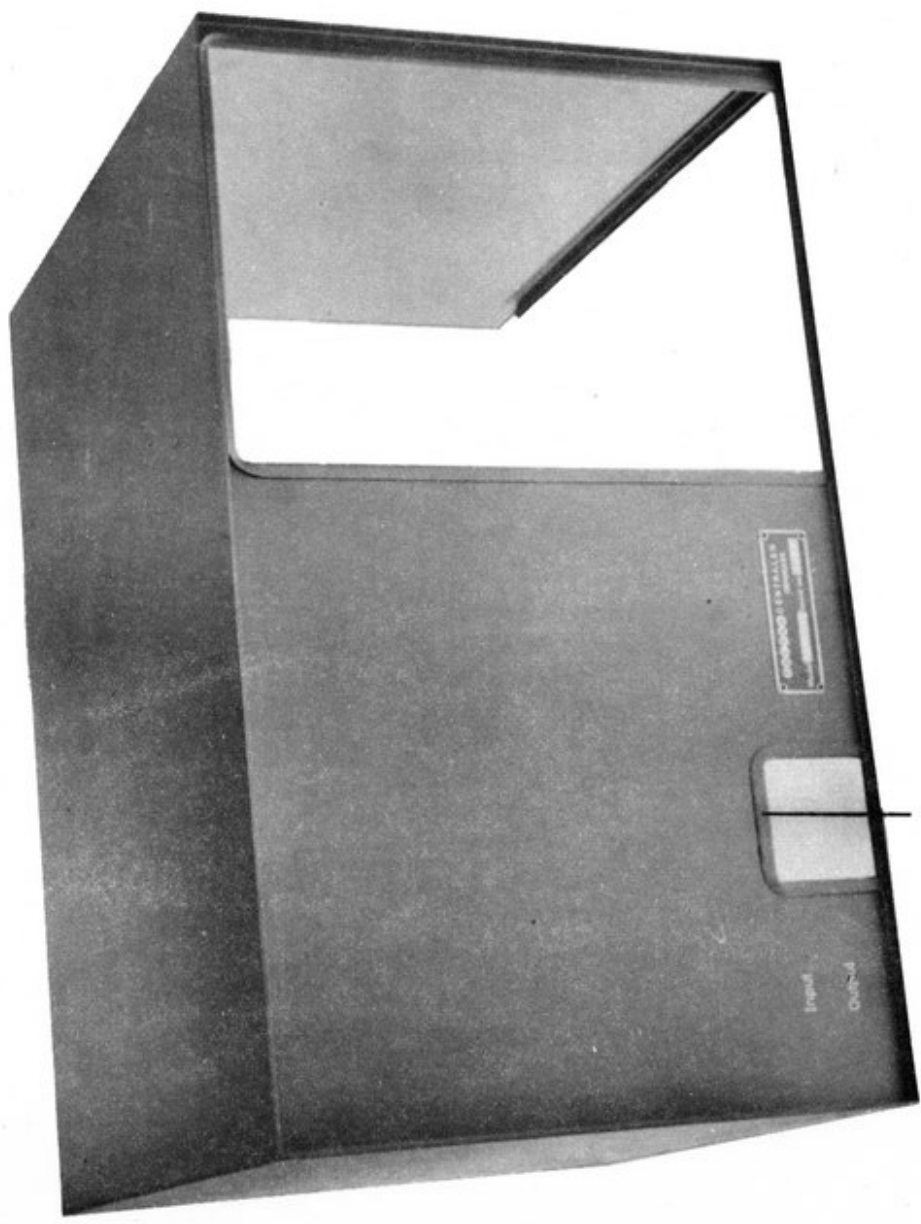

10.00.01

Ref.No.	Qty.	Description	RC Part No.	Note
10.00.00	1	Cabinet Complete	34800	≤ 2165
.00	1	Cabinet Complete	34801	
.01	1	PVC Strip 2 m	34802	

11.00.00 Base Plate, etc.

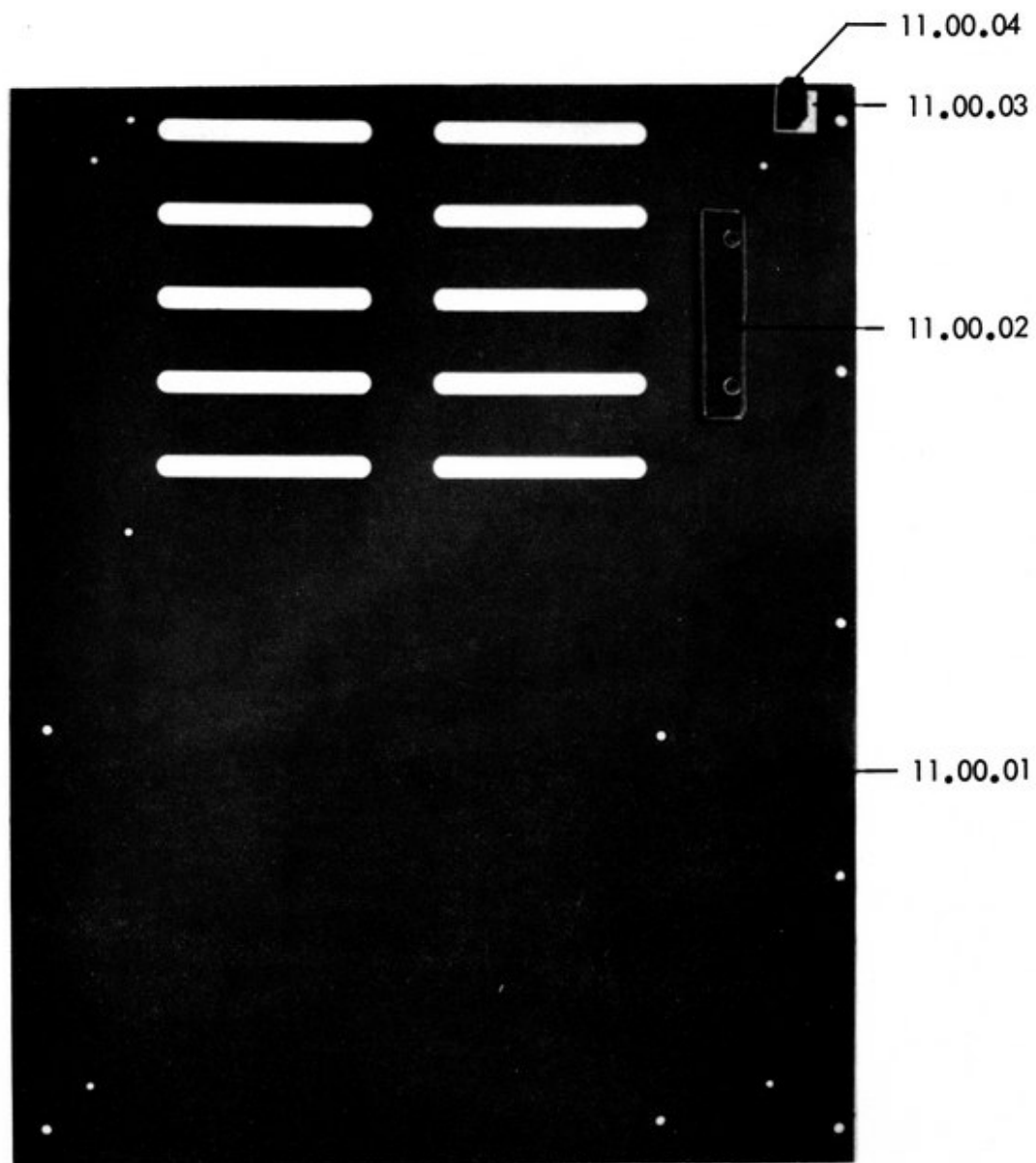

Ref.No.	Qty.	Description	RC Part No.	Note
11.00.00	1	Base Plate, etc.	-	
.01	1	Base Plate	34805	
.02	1	Retaining Plate, PVC	34806	
.03	1	Base Plate, Micro Switch	34807	
.04	1	Support, PVC, Micro Switch	34808	
.05	4	Foot, Nylon	34809	

12.00.00 Basic Frame, Front

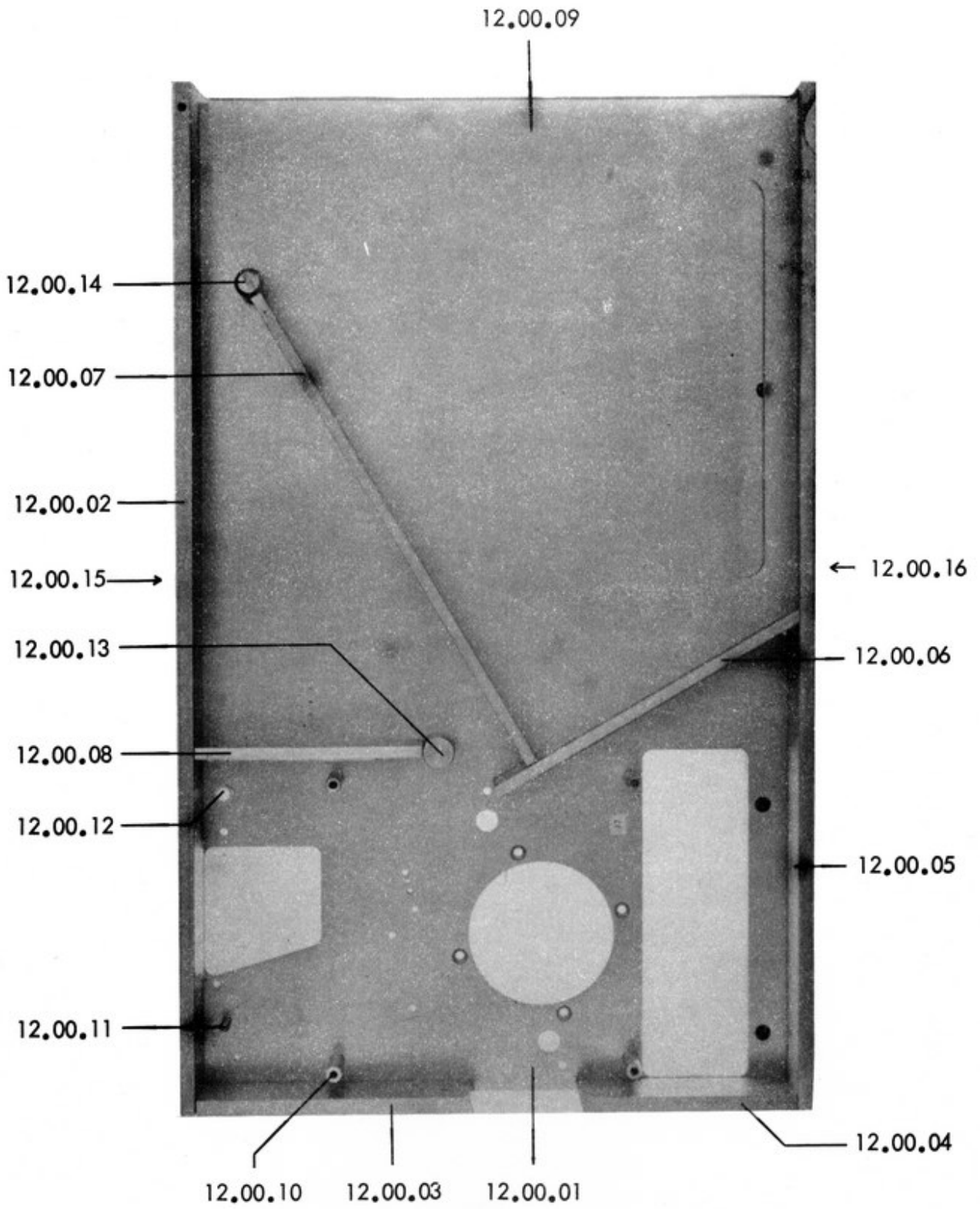

Ref.No.	Qty.	Description	RC Part No.	Note
12.00.00	1	Basic Frame, Front		
.01	1	Basic Frame	34812	
.02	1	Rim	34813	
.03	1	Rim	34814	
.04	1	Rim	34815	
.05	1	Rim	34816	
.06	1	Rim	34817	≅ 2145
.06	1	Rim	34818	
.07	1	Rim	34819	≅ 2145
.07	1	Rim	34900	
.08	1	Rim	34901	
.09	1	Window, Plexiglas	34608	≅ 2145
.09	1	Window, Plexiglas	34703	
.10	4	Spacer	34902	
.11	1	Attachment, Spring	34903	
.12	1	Nipple, Nylon	34904	
.13	1	Guide, Fixed	34905	
.14	1	Guide, Roller assy	34719	
.15	1	Guide, Cabinet	34906	
.16	1	Assembling Bar	34907	

13.00.00 Fan and Filter assemblies

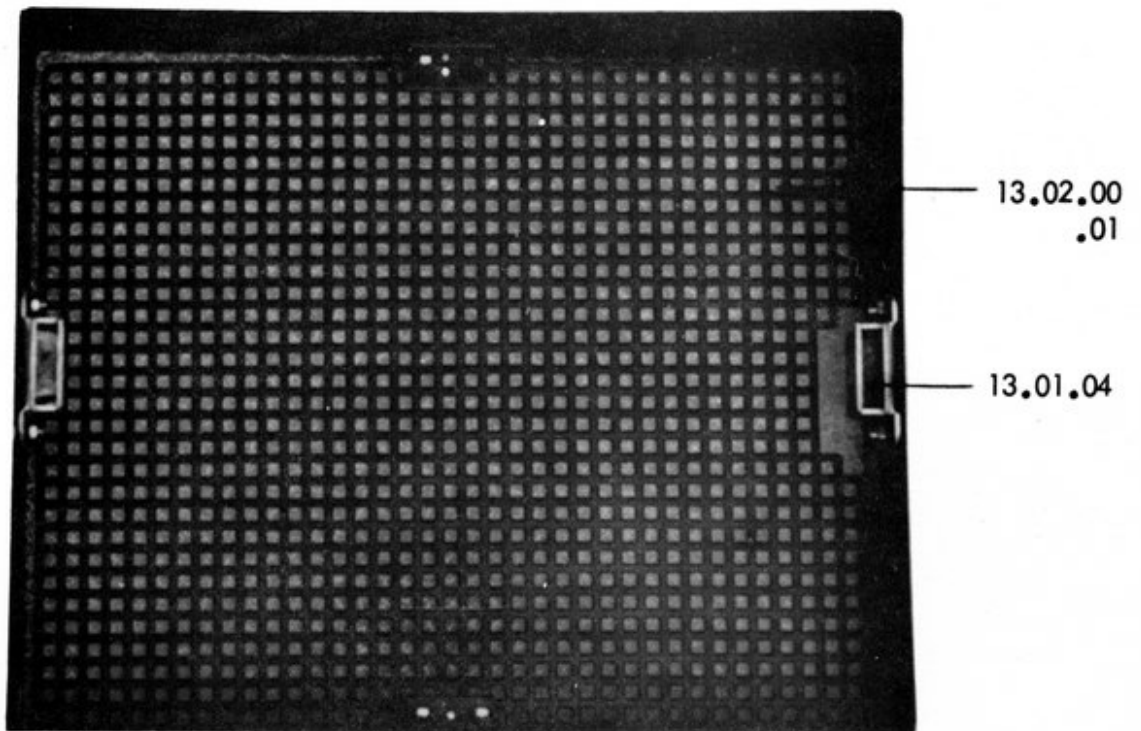
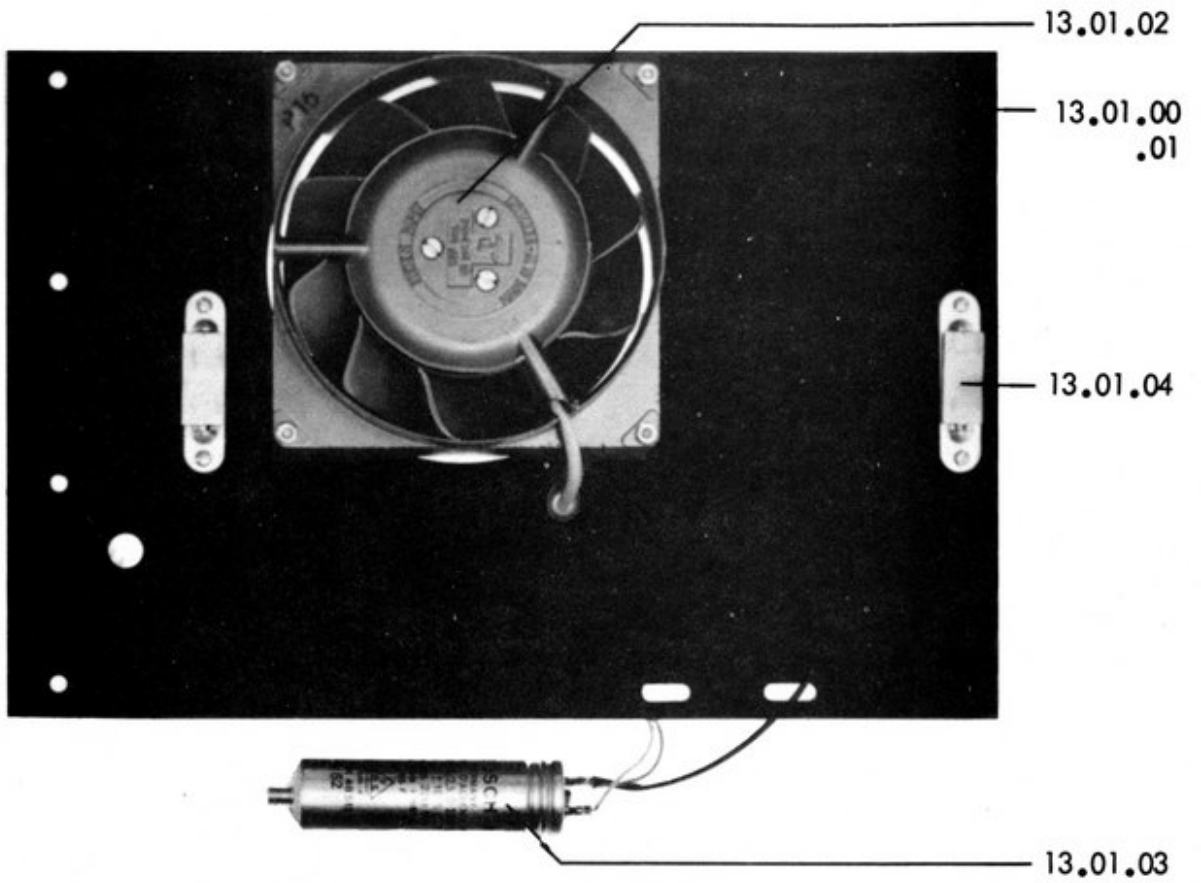

Ref.No.	Qty.	Description	RC Part No.	Note
13.00.00	1	Fan and Filter assy	-	
.01.00	1	Fan assy	-	
.01	1	Base Plate, Fan	34909	≤ 2205
.01	1	Base Plate, Fan	34910	
.02	1	Fan	13513	
.03	1	Capacitor, Fan, 2,5 uF, 220 AC	11109	
.04	2	Lock, Magnetic, Complete	34911	
.05	1	Nipple, Nylon	34912	
.02.00	1	Filter assy	34913	
.01	1	Filter	34710	

14.00.00 Door and Front Plates

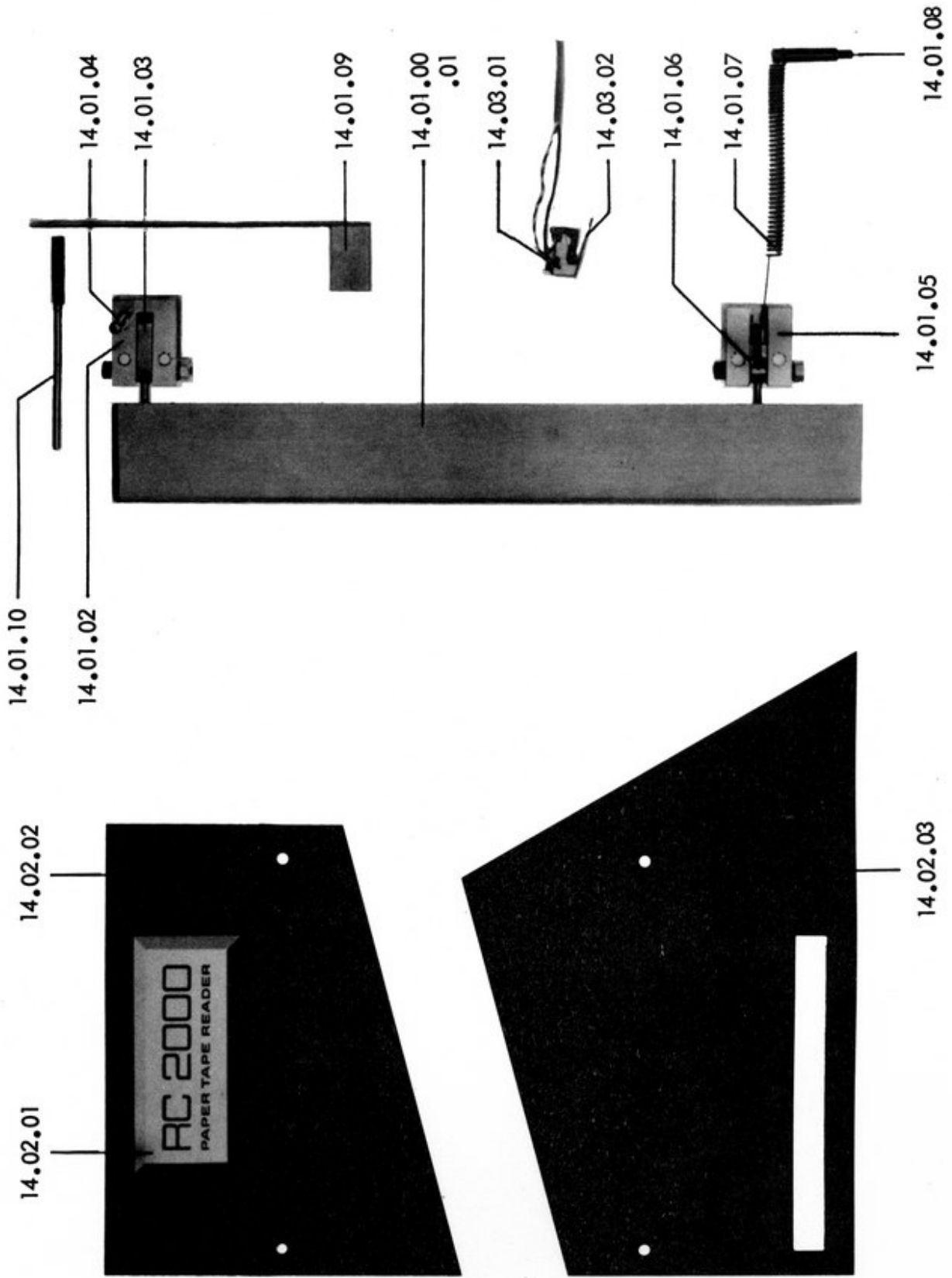

Ref.No.	Qty.	Description	RC Part No.	Note
14.00.00	1	Door and Front Plates	-	
.01.00	1	Door Complete	34916	
.01	1	Door	34610	x)
.02	1	Hinge, Fixed, Upper	34613	
.03	1	Hinge, Movable, Upper	34603	x)
.04	1	Pin, Hinge, Upper	34918	
.05	1	Hinge, Fixed, Lower	34618	
.06	1	Hinge, Movable, Lower	34604	x)
.07	1	Spring	34611	
.08	1	Attachment, Spring	34917	
.09	1	Flat Spring	34919	
.10	1	Door Release	34915	
.02.01	1	Name-Plate	35000	
.02	1	Cover Plate	35001	
.03	1	Cover Plate	35002	
.03.01	1	Micro Switch	12511	
.02	1	Actuator, Spring	12510	
x) If Hinge Movable is 5 mm ϕ , then order ref. No. 14.01.01, 14.01.03 and 14.01.06 together				

15.00.00 Pressure Lid and Tape Guide Assemblies

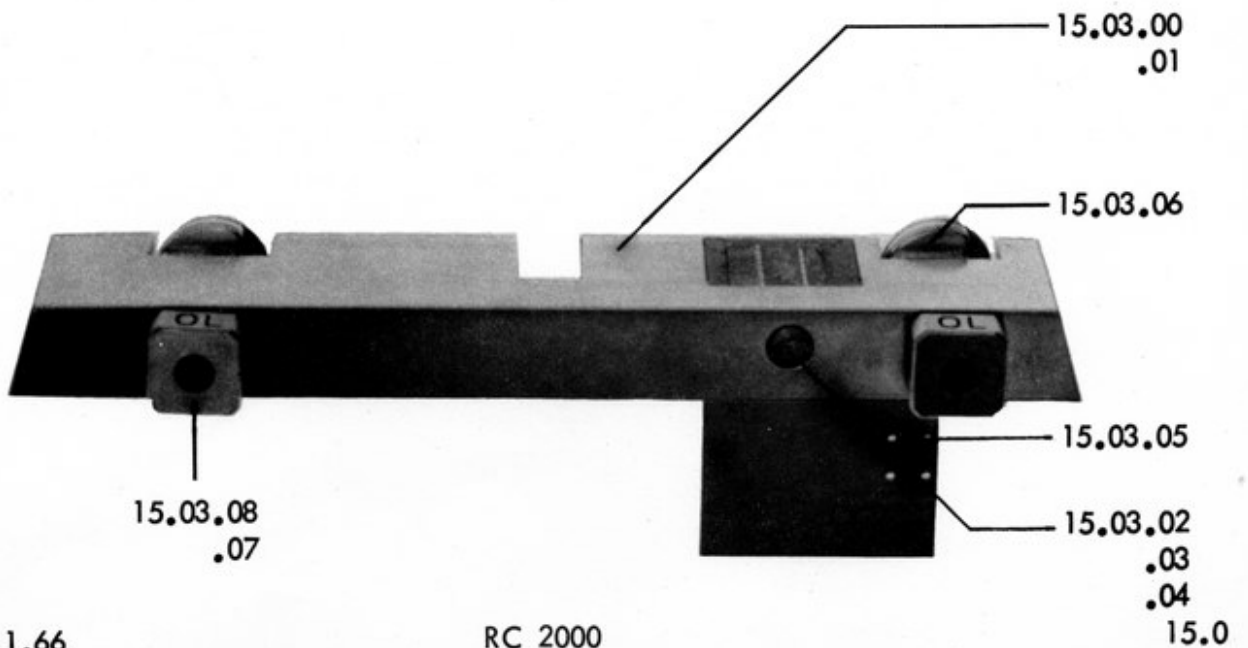
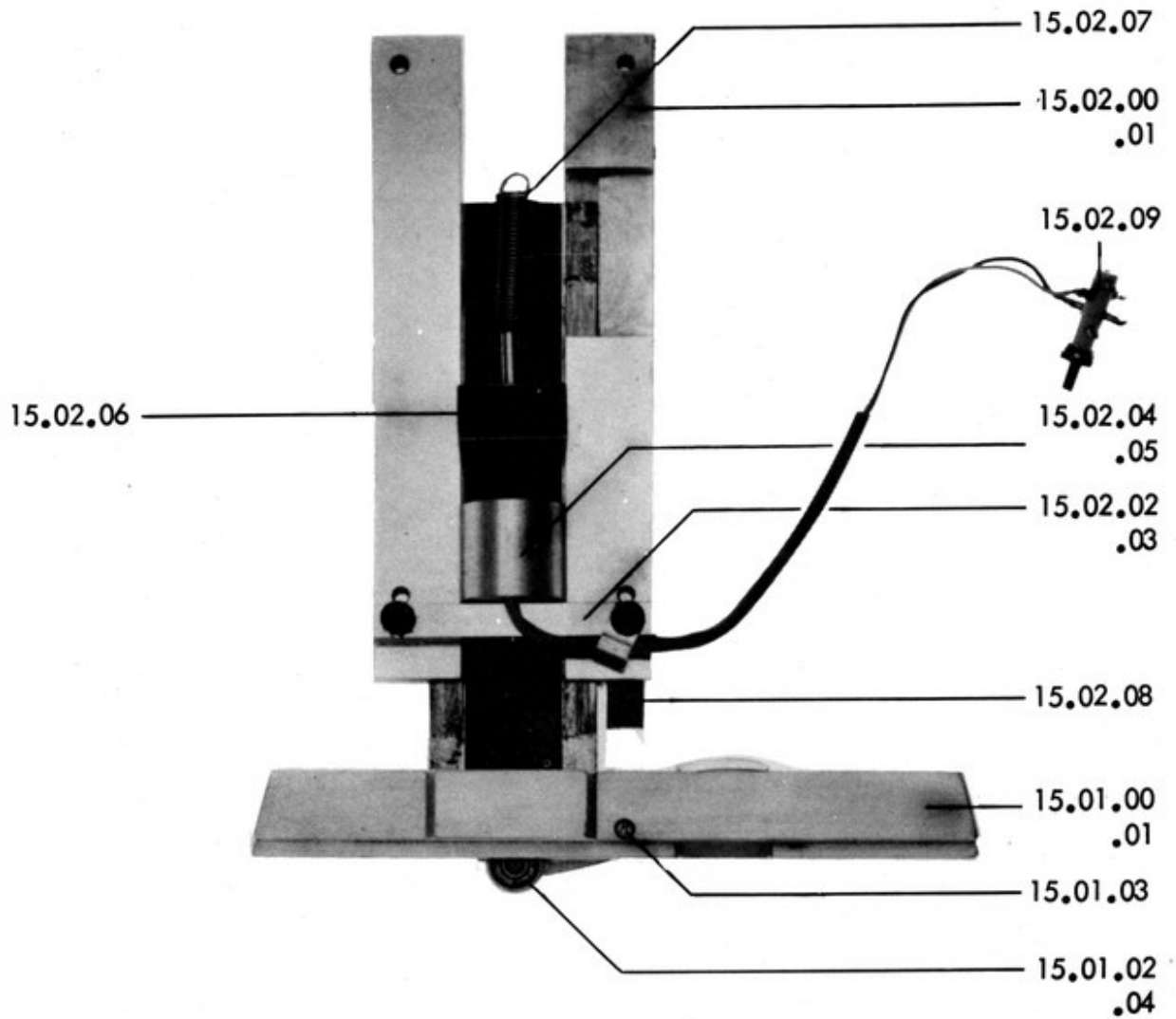

Ref.No.	Qty.	Description	RC Part No.	Note
15.00.00	1	Pressure Lid and Tape Guide assy	35213	
.01.00	1	Pressure Lid Complete	34711	
.01	1	Pressure Lid including Lens	35215	
.02	1	Pinch Roller	34602	
.03	1	Pivot, Pinch Roller	35217	
.04	1	Spring, Pinch Roller	34712	
.02.00	1	Slide Assy Complete	34714	
.01	1	Guide Shoes and Slide Bar assy	35212	
.02	1	Support, Magnet	35216	
.03	1	Screw and Retaining Ring, Magnet	35300	
.04	1	Magnet with Solenoid	35301	x)
.05	1	Solenoid	34708	x)
.06	1	Armature with Attachment	35302	
.07	1	Spring	34713	
.08	1	Rubber	35303	
.09	1	Stand Off	35304	
.03.00	1	Tape Guide Complete	34709	
.01	1	Tape Guide	35305	
.02	1	Adjustment Screw	35306	
.03	2	Spring Flat	35307	
.04	1	Retaining Screw, Spring Flat	35308	
.05	1	Mounting Plate	35309	
.06	2	Selector Block	34707	
.07	2	Spring, Selector	35310	
.08	2	Selector Knob	35311	
x) If the magnet is 12 mm high, then order ref. No. 15.02.00				

16.00.00 Push Button Unit

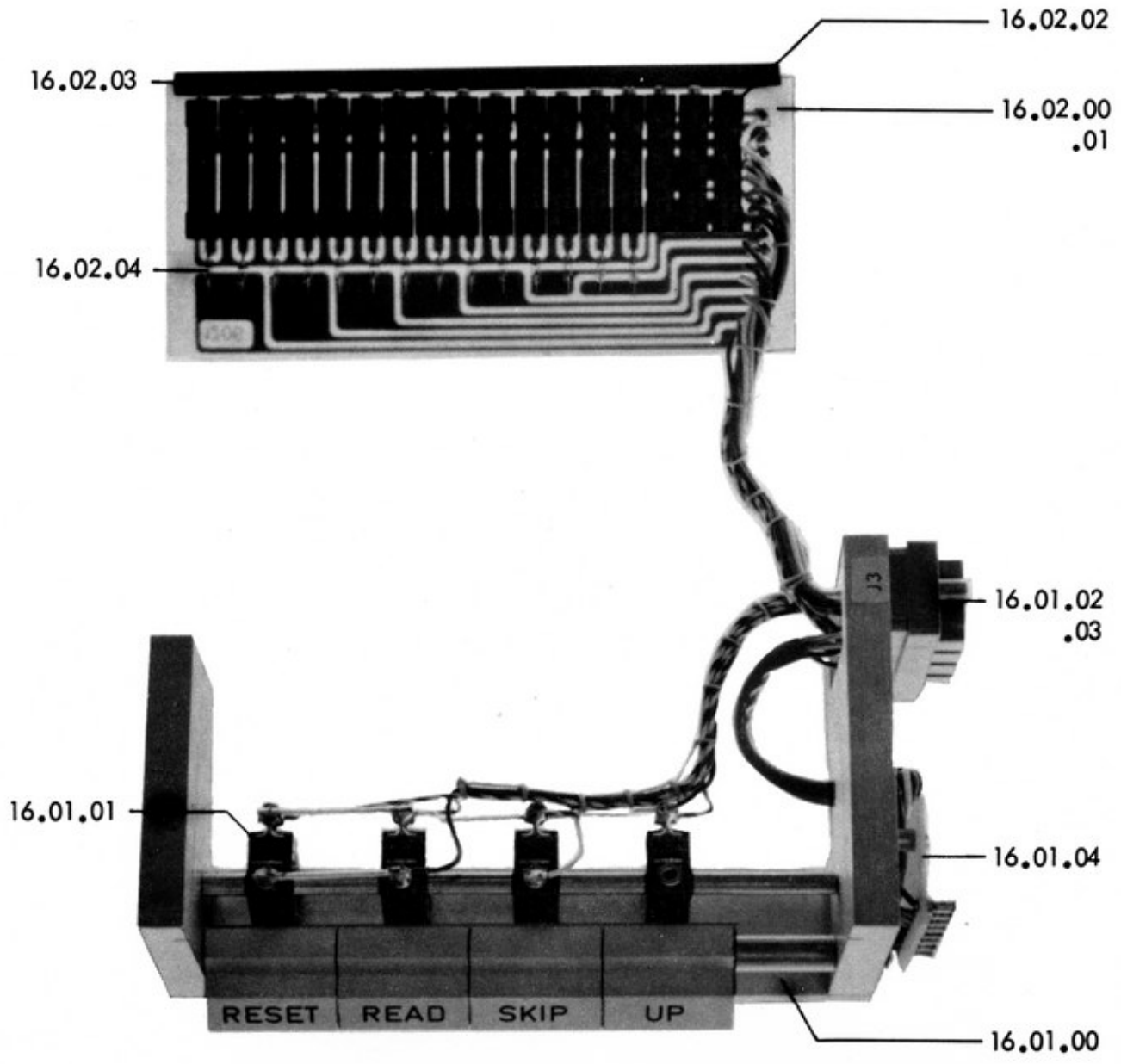

Ref.No.	Qty.	Description	RC Part No.	Note
16.00.00	1	Push Button Unit	35200	
.01.00	1	Push Button assy	35201	
.01	4	Micro Switch	12514	
.02	1	Elco Jack, 38 pins	13712	
.03	38	Crimp Contacts	13700	
.04	1	Terminal Board	35202	
.02.00	1	Printed Circuit Card 1206 complete	35203	≤ 2165
.01	1	Print 1206	35204	
.02	17	Potentiometer, Spectrol 5K	10904	
.00	1	Printed Circuit Card 1206 A complete	35205	> 2165
.01	1	Print 1206 A	35206	
.02	17	Potentiometer, Amphenol 5K	35207	
.03	1	Name Rim	35208	
.04	14	Diode OA 95	11600	

17.00.00 Selector Switch Board Assembly

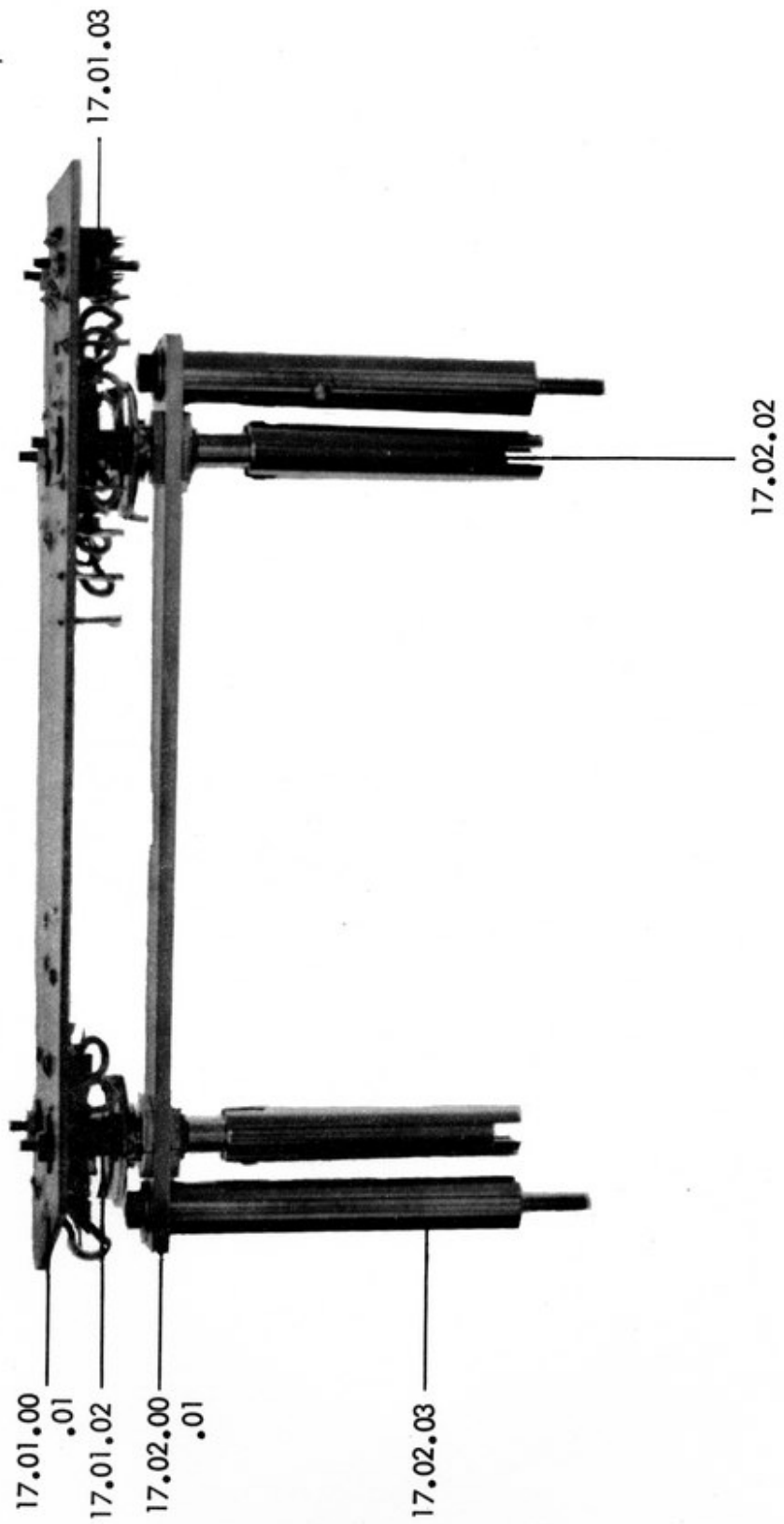

Ref.No.	Qty.	Description	RC Part No.	Note
17.00.00	1	Selector Switch Board assy	-	
.01.00	1	Printed Circuit Card 1231 complete	35103	
.01	1	Print 1231	35519	
.02	2	Selector Switch	35104	
.03	1	Harting Jack, 20 pins, female	35416	≤ 2165
.03	1	Elco Jack, 32 pins	35105	
.02.00	1	Selector Switch, Mechanical assy	35106	
.01	1	Mounting Bar	35107	
.02	2	Universal Joint Joke	35108	
.03	2	Spacer	35109	

18.00.00 Lamps and Photocells

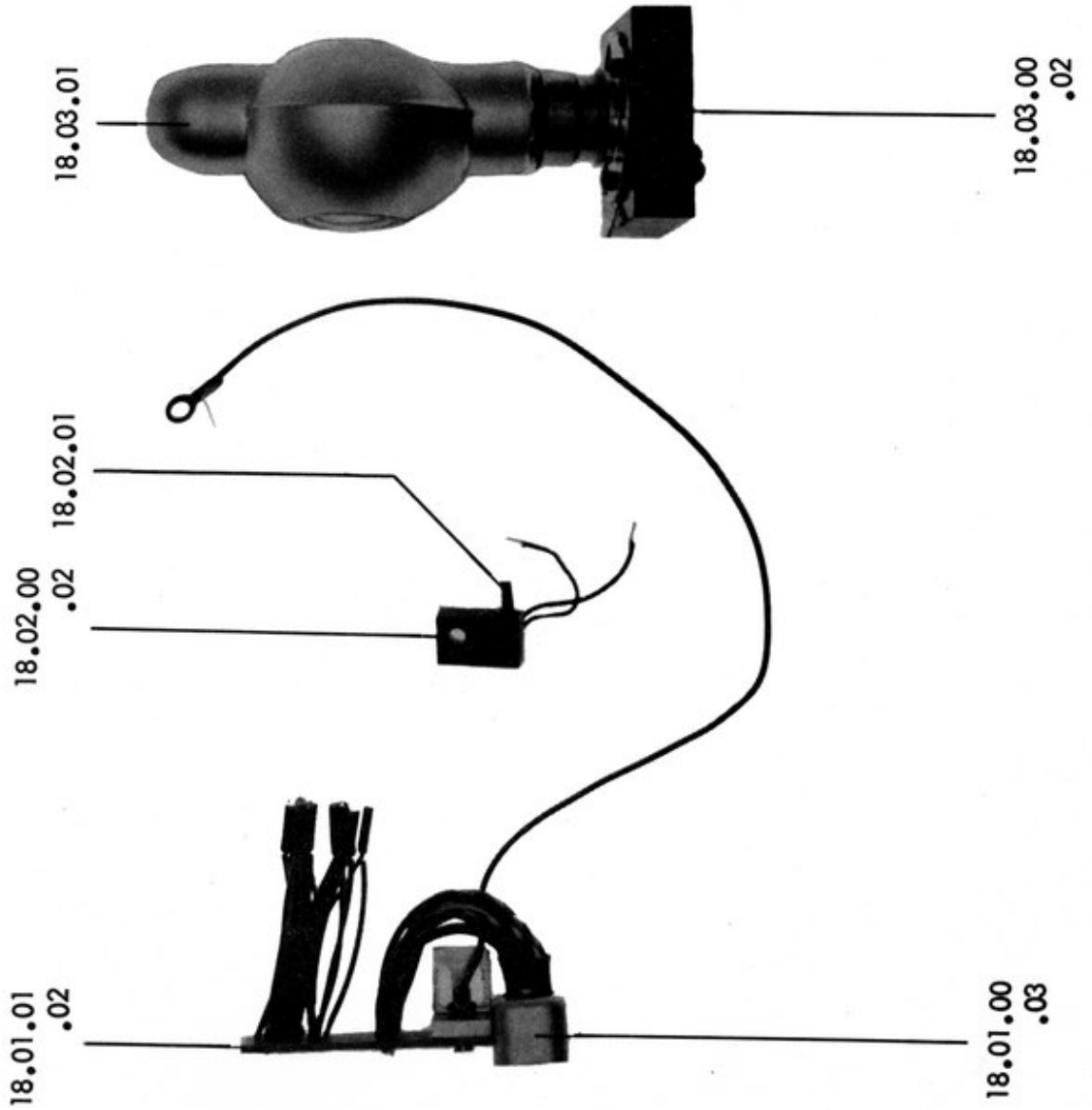

Ref.No.	Qty.	Description	RC Part No.	Note
18.00.00	1	Lamp and Photo Cells	-	
.01.00	1	Photo Sense assy	35112	
.01	1	Print 1652	35113	
.02	17	Photo Transistor 33 F2	34701	
.03	1	Connector with Support, 14 pins	35114	
.04	1	Transistor Mounting Guide	35115	
.02.00	1	Light Sense assy	35117	
.01	1	Photo Transistor 33 F2	34701	
.02	1	Support, Photo Transistor	35118	
.03.00	1	Lamp assy	35116	
.01	1	Lamp	34702	
.02	1	Lamp Socket	35119	

19.00.00 Capstan Motor Assembly



Ref.No.	Qty.	Description	RC Part No.	Note
19.00.00	1	Capstan Motor assy	-	
.01	1	Capstan Motor	34600	
.02	4	Brush, Capstan Motor	35004	
.03	1	Capstan	34601	
.04	1	Harting Plug, 14 pins	35005	≤ 2205
.04	1	Elco Plug, 20 pins 8016/20	13715	
.05	1	Plug Cover (for Harting)	35007	

20.00.00 Mains Switch Assembly

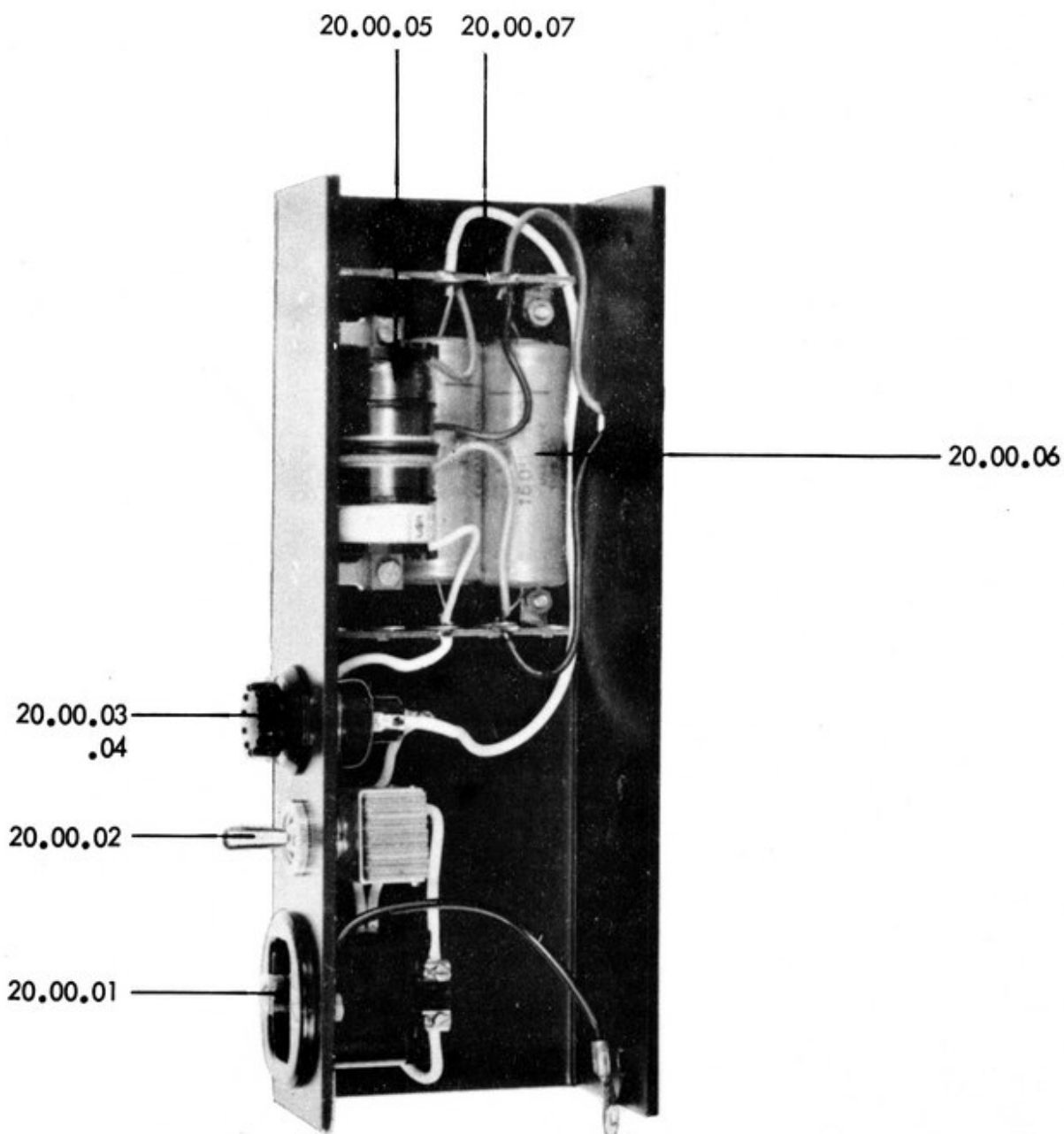

Ref.No.	Qty.	Description	RC Part No.	Note
20.00.00	1	Mains Switch assy	-	
.01	1	Connector Male	12218	
.02	1	Power Switch	35210	
.03	1	Fuse Holder	22403	
.04	1	Fuse 2 Amp, 5 × 20 mm	20806	
.05	1	Noise Filter	13203	
.06	2	Capacitor 0,1 uF, 1600 VDC	11111	
.07	2	Terminal Board	35211	
20.01.00	1	Power Cable (3,5 m)	34619	

21.00.00 Power Supply < 2205

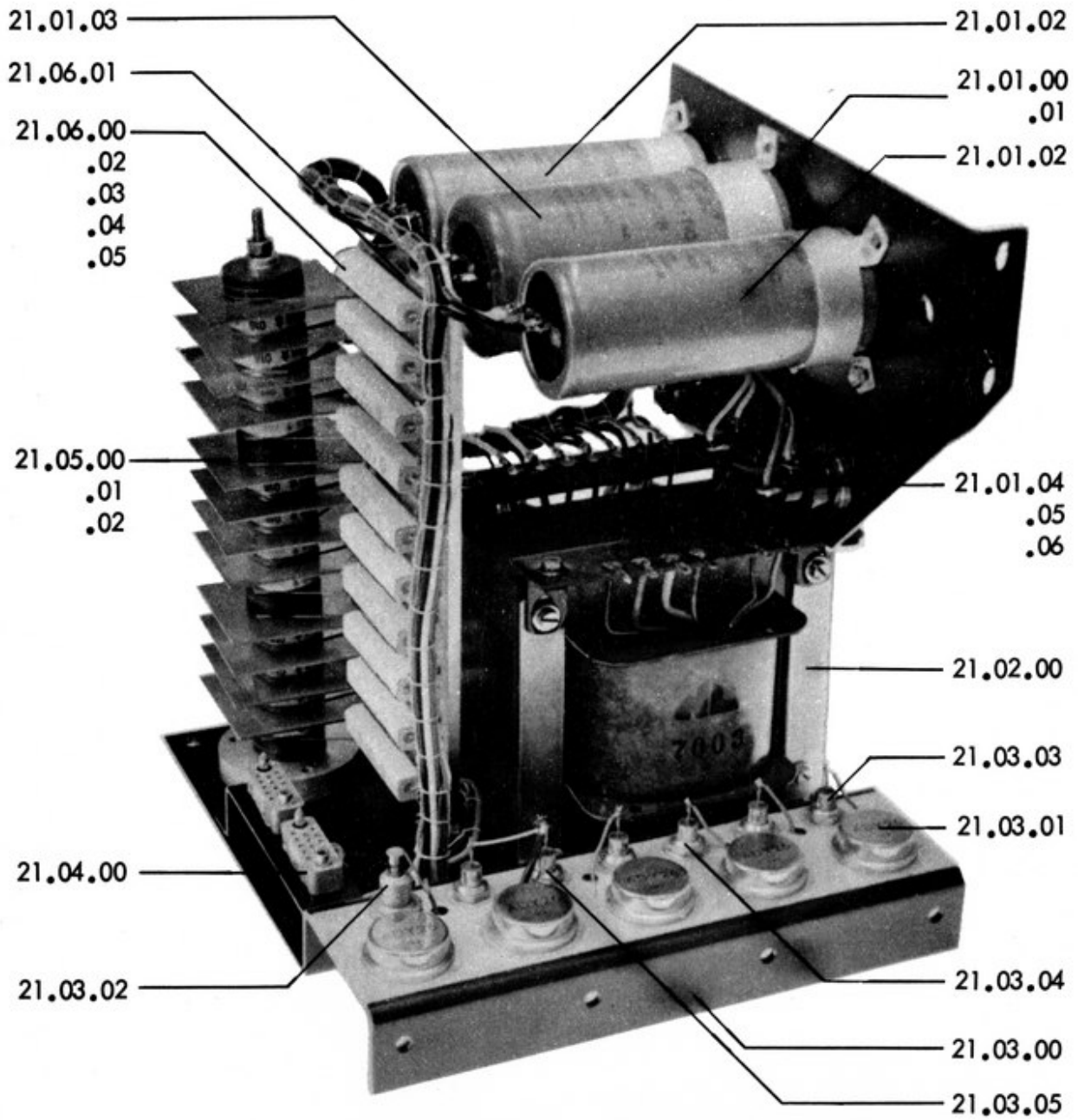

Ref.No.	Qty.	Description	RC Part No.	Note
21.00.00	1	Power Supply Complete	-	≤ 2205
.01.00	1	Capacitor and Fuse Bank	35009	
.01	1	Mounting Plate	35010	
.02	2	Capacitor 10.000 uF, 25/30 V	35011	
.03	1	Capacitor 8.000 uF, 50/60 V	35012	
.04	4	Fuse Holder	22403	
.05	1	Fuse 3 Amp, 5 × 20 mm	20808	
.06	3	Fuse 6 Amp, 5 × 20 mm	20811	
.07	1	Capacitor 2.000 uF, 25/30 V	35013	
.08	1	Capacitor 3.000 uF, 12/15 V	35014	
.02.00	1	Transformer	34612	
.03.00	1	Semi Conductor Panel	35016	
.01	5	Transistor ADY 26	21204	
.02	1	Diode OA 31	21812	
.03	3	Diode BZZ 18	21718	
.04	1	Diode BZZ 16	21716	
.05	2	Diode BYZ 13	11616	
.04.00	2	Harting Jack, 14 pins	35017	
.05.00	1	Rectifier Stack Complete	35018	
.01	6	Diode AR 8	21811	
.02	6	Diode KR 8	21810	
.06.00	1	Resistor Panel	-	
.01	1	Terminal Board	35100	
.02	3	Resistor 4 ohm 11 w	34614	
.03	2	Resistor 5 ohm 11 w	34615	
.04	2	Resistor 10 ohm 11 w	34616	
.05	3	Resistor 50 ohm 11 w	34617	
		See also Ref. No. 24.00.00		

22.00.00 Control Electronics

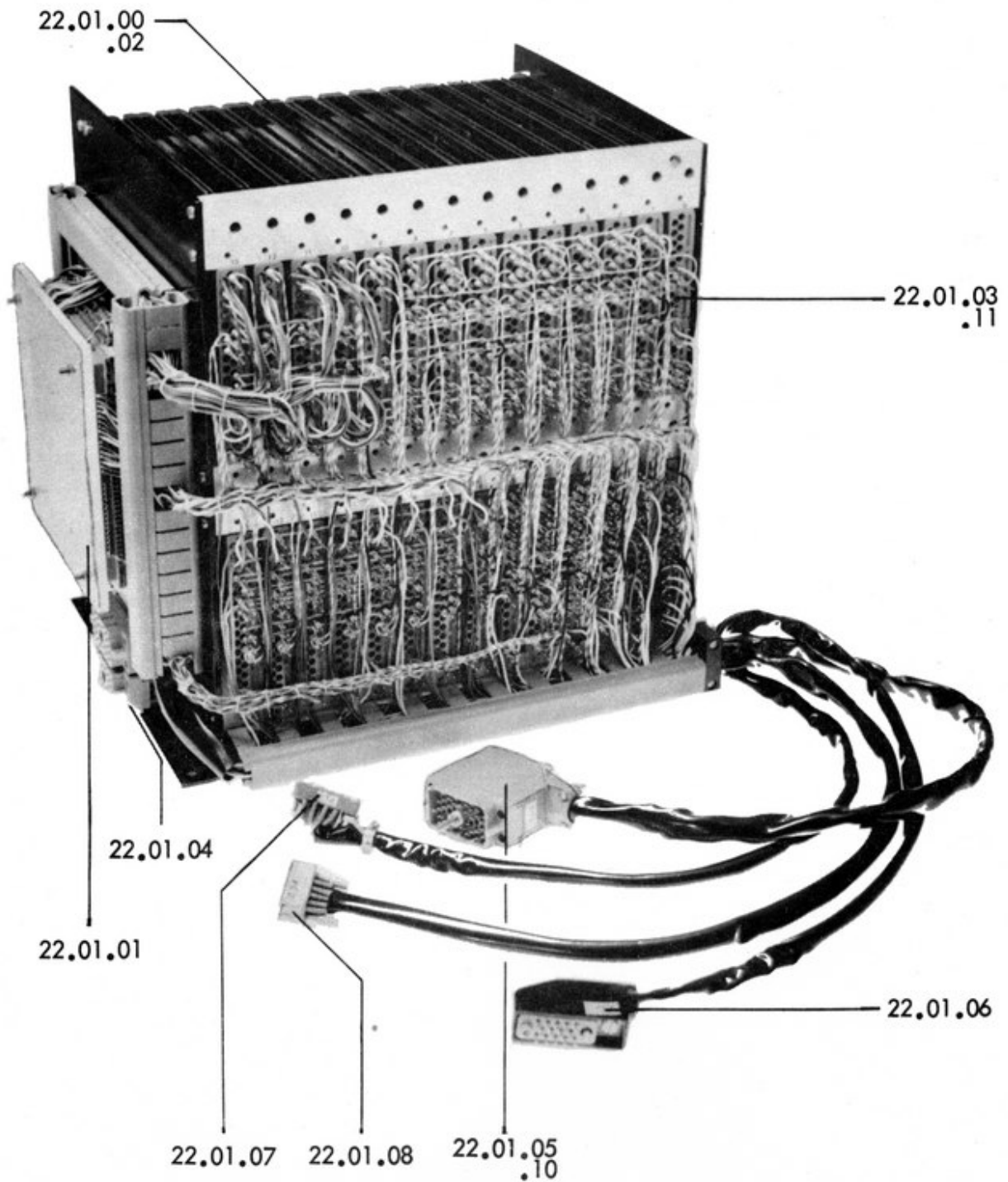

Ref.No.	Qty.	Description	RC Part No.	Note
22.00.00	1	Control Electronics complete with parts 35406, 13706, 13712, 35110 13715	35404	x)
.01.00	1	Card Cage, wired with Core Store and Plugs, as 22.00.00 without PC Cards	35405	
.01	1	Core Store	35414	
.02	42	Guide PC Cards	13908	≤ 2165
.02	42	Guide PC Cards	35406	
.03	56	Siemens Jack, 15 pins	12206	≤ 2165
.03	28	Elco Jack 7023-35, 35 pins	13706	
.04	2	Tuchel Jack, 30 pins, male	12207	≤ 2165
.04	2	Elco Jack, 38 pins, 8016-38	13712	
.05	1	Elco Plug, 38 pins, 8016-38	13713	
.06	1	Harting Plug, 20 pins, male	35417	≤ 2165
	1	Harting Plug, Cover	35418	≤ 2165
.06	1	Elco Plug with 32 special pins	35110	
.07	1	Harting Plug Min. 14, male	35005	≤ 2205
	1	Harting Plug, Cover	35007	≤ 2205
.07	1	Elco Plug, 20 pins	13715	
.08	1	Continental Plug, SM-14	35410	
	1	Continental Plug, Cover	35411	
.09	1	Transition Cable for Elco Plug 07 and Harting Jack corresponding to 07	35412	
.10		Elco pins crimp	13700	
.11		Elco pins wrap	13703	
<p>x) Control Electronics 22.00.00 is replacement part for RC 2000 with No. ≥ 2165. However transition cable 09 is used for RC 2000 with No. ≤ 2205.</p> <p>Complete Control Electronic is not available for RC 2000 with No. ≤ 2165.</p>				

24.00.00 Power Supply

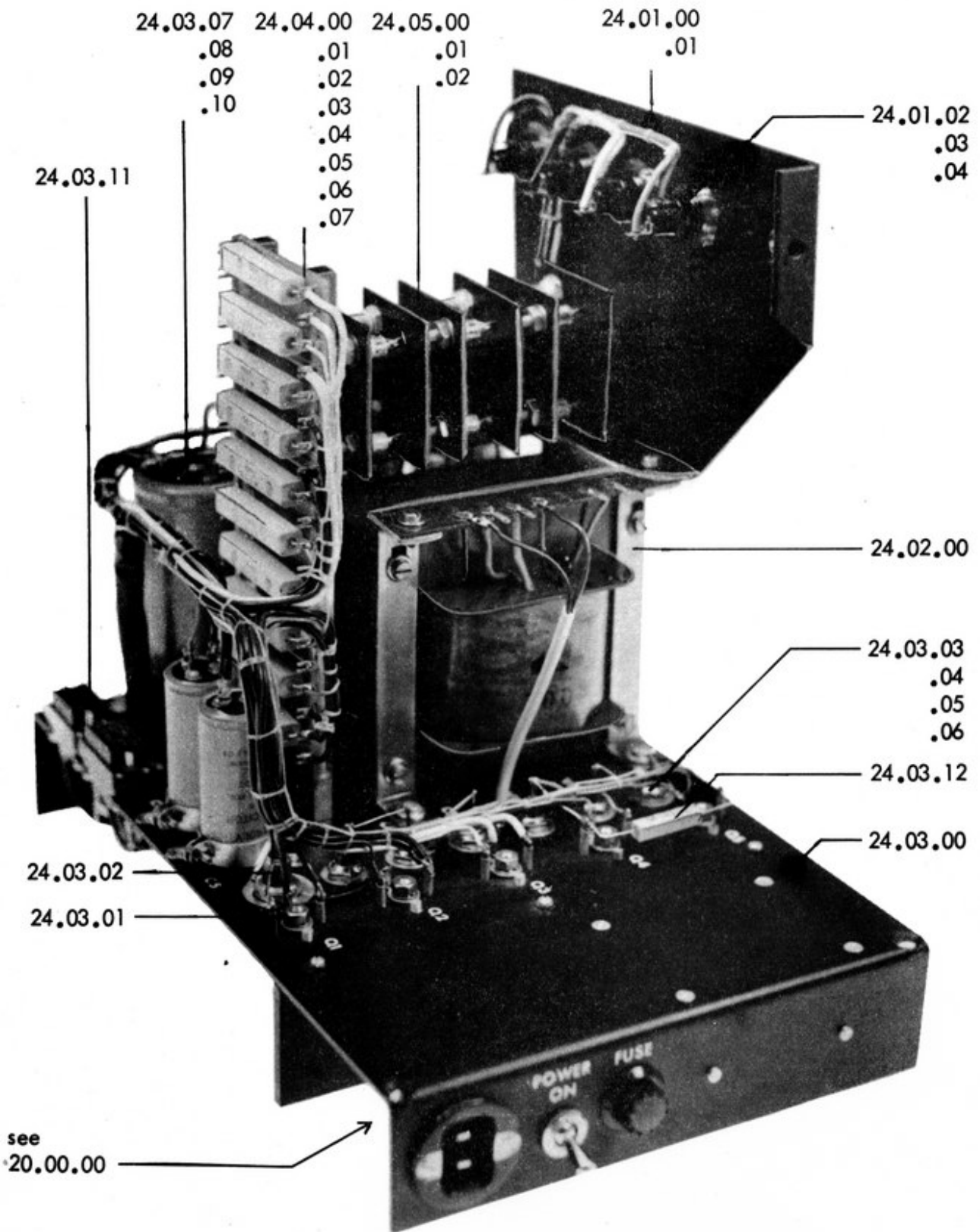

Ref.No.	Qty.	Description	RC Part No.	Note	
24.00.00	1	Power Supply Complete	35008	> 2205	
.01.00	1	Fuse Panel	35313		
.01	1	Mounting Plate	35314		
.02	4	Fuse Holder	22403		
.03	1	Fuse 3 Amp, 5 x 20 mm	20808		
.04	3	Fuse 6 Amp, 5 x 20 mm	20811		
.02.00	1	Transformer	34612		
.03.00	1	Base Plate	35315		
.01	5	Transistor ADY 26	21204		
.02	1	Diode OA 31	21812		
.03	2	Diode BZZ 17	21717		
.04	1	Diode BZZ 18	21718		
.05	1	Diode BZZ 16	21716		
.06	2	Diode BYZ 13	11616		
.07	1	Capacitor 2.000 uF, 25/30 V	35013		
.08	1	Capacitor 3.000 uF, 12/15 V	35014		
.09	2	Capacitor 10.000 uF, 25/30 V	35011		
.10	1	Capacitor 8.000 uF, 50/60 V	35012		
.11	2	Elco Jack, 20 pins	13714		
.12	1	Resistor 300 ohm 9 w	35316		
.04.00	1	Resistor Panel	-		
.01	1	Terminal Board	35317		
.02	3	Resistor 4 ohm 11 w	34614		
.03	2	Resistor 5 ohm 11 w	34615		
.04	2	Resistor 10 ohm 11 w	34616		
.05	1	Resistor 50 ohm 11 w	34617		
.06	1	Resistor 45 ohm 11 w	35318		
.07	1	Resistor 25 ohm 11 w	35319		
.05.00	1	Rectifier Stack Complete	35400		
.01	6	Diode Westinghouse 367 B	21911		
.02	6	Diode Westinghouse 367 B,R	21912		
		See also Mains Switch assy page 20.1			

Ref.No.	Qty.	Description	RC Part No.	Note
40.00.00	1	Printed Circuit Card 1200 complete	35509	
.01	1	Print 1200	35518	
.02	1	Elco Plug 7023, 35 pins	13707	
.03	7	Transistor SFT 228	11507	
.04	8	Diode OA 85	21301	
.05	3	Diode OA 200	21303	
.06	1	Resistor 100 ohm 1/3 w	10307	
.07	1	Resistor 200 ohm 1/3 w	10314	
.08	1	Resistor 430 ohm 1/3 w	10402	
.09	1	Resistor 1 K 1/3 w	10411	
.10	1	Resistor 2 K 1/3 w	10418	
.11	3	Resistor 5,6 K 1/3 w	10509	
.12	3	Resistor 6,8 K 1/3 w	10511	
.13	3	Resistor 8,2 K 1/3 w	10513	
.14	4	Resistor 27 K 1/3 w	15908	
.15	1	Resistor 1,5 K 1/2 w	15512	
.16	5	Resistor 3 K 1/2 w	15519	
.17	4	Resistor 30 ohm HSS 1%	22312	
.18	5	Capacitor 390 pF	15218	
.19	1	Capacitor 470 pF	11006	
.20	1	Capacitor 560 pF	15219	
.21	1	Capacitor 820 pF	11008	
.22	1	Capacitor 1 nF	15215	
.23	1	Capacitor 0,47 uF MKL	11103	
For RC 2000 with serial No. less or equal to 2165 the description and RC part No. are changed for the following REF. Nos.				
40.00.00	1	Printed Circuit Card 1200 complete	35609	
.01	1	Print 1200	35618	
.02	2	Siemens Plug, 15 pins	12205	

Ref.No.	Qty.	Description	RC Part No.	Note
41.00.00	1	Printed Circuit Card 1200-1 complete	35508	
.01	1	Print 1200	35518	
.02	1	Elco Plug 7023, 35 pins	13707	
.03	6	Transistor SFT 228	11507	
.04	1	Transistor 2N 388	11501	
.05	10	Diode OA 85	21301	
.06	2	Diode OA 95	11600	
.07	1	Diode OA 200	21303	
.08	2	Resistor 1 K 1/3 w	10411	
.09	3	Resistor 5,6 K 1/3 w	10509	
.10	1	Resistor 6,2 K 1/3 w	10510	
.11	3	Resistor 6,8 K 1/3 w	10511	
.12	2	Resistor 8,2 K 1/3 w	10513	
.13	3	Resistor 27 K 1/3 w	15908	
.14	1	Resistor 100 K 1/3 w	16002	
.15	6	Resistor 3 K 1/2 w	15519	
.16	2	Capacitor 150 pF	11003	
.17	7	Capacitor 390 pF	15218	
.18	1	Capacitor 0,47 uF MKL	11103	
.19	1	Capacitor 2,2 uF MKL	11105	
For RC 2000 with serial No. less or equal to 2165 the description and RC part No. are changed for the following REF. Nos.				
41.00.00	1	Printed Circuit Card 1200-1 complete	35608	
.01	1	Print 1200	35618	
.02	2	Siemens Plug, 15 pins	12205	

Ref.No.	Qty.	Description	RC Part No.	Note
42.00.00	8	Printed Circuit Card 1201 complete	35507	
.01	1	Print 1201	35517	
.02	1	Elco Plug 7023, 35 pins	13707	
.03	6	Transistor SFT 228	11507	
.04	1	Transistor 2N 388	11501	
.05	37	Diode OA 95	11600	
.06	4	Resistor 2 K 1/8 w	10607	
.07	1	Resistor 3 K 1/8 w	10611	
.08	4	Resistor 4,3 K 1/8 w	10615	
.09	4	Resistor 4,7 K 1/8 w	10616	
.10	7	Resistor 10 K 1/8 w	10704	
.11	7	Resistor 27 K 1/8 w	10714	
.12	4	Resistor 3 K 1/2 w	15519	
.13	8	Capacitor 390 pF	15218	
.14	1	Capacitor 0,47 uF	11103	
For RC 2000 with serial No. less or equal to 2165 the description and RC part No. are changed for the following REF. Nos.				
42.00.00	8	Printed Circuit Card 1201 complete	35607	
.01	1	Print 1201	35617	
.02	2	Siemens Plug, 15 pins	12205	

Ref.No.	Qty.	Description	RC Part No.	Note
43.00.00	8	Printed Circuit Card 1202 complete	35506	
.01	1	Print 1202	35516	
.02	2	Elco Plug 7023, 35 pins	13707	
.03	6	Transistor SFT 228	11507	
.04	1	Transistor SFT 288	21001	
.05	3	Transistor 2N 388	11501	
.06	2	Transistor 2N 2048	11504	
.07	2	Transistor V 410	21916	
.08	3	Diode OA 95	11600	
.09	8	Diode HG 5002	11602	
.10	1	Resistor 27 ohm 1/8 w	15010	
.11	2	Resistor 100 ohm 1/8 w	15104	
.12	3	Resistor 220 ohm 1/8 w	15112	
.13	6	Resistor 1 K 1/8 w	10600	
.14	1	Resistor 1,5 K 1/8 w	10604	
.15	4	Resistor 2 K 1/8 w	10607	
.16	1	Resistor 3,3 K 1/8 w	10612	
.17	1	Resistor 3,9 K 1/8 w	10614	
.18	5	Resistor 5,6 K 1/8 w	10618	
.19	1	Resistor 10 K 1/8 w	10704	
.20	4	Resistor 15 K 1/8 w	10708	
.21	1	Resistor 16 K 1/8 w	10709	
.22	1	Resistor 27 K 1/8 w	10714	
.23	1	Resistor 51 K 1/8 w	10801	
.24	1	Resistor 56 K 1/8 w	10802	
.25	1	Resistor 82 K 1/8 w	10806	
.26	1	Resistor 100 K 1/8 w	10808	
.27	2	Resistor 15 ohm HSS 1%	22313	
.28	3	Capacitor 0,1 uF	11101	
.29	1	Capacitor 0,47 uF MKL	11103	
.30	1	Capacitor 100 uF 16 v	11215	
.31	4	Capacitor 390 pF	15218	
.32	1	Potcore K 300.210	22300	
.33	1	Coil	22306	
For RC 2000 with serial No. less or equal to 2165 the description and RC part No. are changed for the following REF. Nos.				
43.00.00	8	Printed Circuit Card 1202 complete	35606	
.01	1	Print 1202	35616	
.02	2	Siemens Plug, 15 pins	12205	

Ref.No.	Qty.	Description	RC Part No.	Note
44.00.00	4	Printed Circuit Card 1203 complete	35505	
.01	1	Print 1203	35515	
.02	1	Elco Plug 7023, 35 pins	13707	
.03	16	Transistor SFT 288	11507	
.04	3	Transistor 2N 388	11501	
.05	48	Diode HG 5002	11602	
.06	16	Resistor 560 ohm 1/3 w	10405	
.07	3	Resistor 1,2 K 1/3 w	10413	
.08	2	Capacitor 390 pF	15218	
.09	1	Capacitor 2,2 nF	14904	
.10	2	Capacitor 0,47 uF MKL	11103	
For RC 2000 with serial No. less or equal to 2165 the description and RC part No. are changed for the following REF. Nos.				
44.00.00	4	Printed Circuit Card 1203 complete	35605	
.01	1	Print 1203	35615	
.02	2	Siemens Plug, 15 pins	12205	

Ref.No.	Qty.	Description	RC Part No.	Note
45.00.00	1	Printed Circuit Card 1205-1 complete	35504	
.01	1	Print 1205	35514	
.02	1	Elco Plug 7023, 35 pins	13707	
.03	3	Transistor SFT 228	11507	
.04	6	Transistor 2N 388	11501	
.05	3	Transistor V 410	21916	
.06	1	Diode BZY 66	21412	
.07	2	Diode OA 200	21303	
.08	1	Diode Z 10	21509	
.09	1	Resistor 10 ohm 1/3 w	10301	
.10	1	Resistor 200 ohm 1/3 w	10314	
.11	2	Resistor 330 ohm 1/3 w	10319	
.12	1	Resistor 390 ohm 1/3 w	10401	
.13	2	Resistor 1 K 1/3 w	10411	
.14	1	Resistor 1,2 K 1/3 w	10413	
.15	1	Resistor 1,6 K 1/3 w	10416	
.16	1	Resistor 3 K 1/3 w	10502	
.17	1	Resistor 5,6 K 1/3 w	10509	
.18	3	Resistor 10 K 1/3 w	10515	
.19	1	Resistor 12 K 1/3 w	15819	
.20	1	Resistor 18 K 1/3 w	15904	
.21	2	Resistor 27 K 1/3 w	15908	
.22	1	Resistor 30 K 1/3 w	15909	
.23	1	Resistor 51 K 1/3 w	15915	
.24	1	Resistor 100 K 1/3 w	16002	
.25	1	Resistor 200 K 1/3 w	16009	
.26	1	Resistor 110 ohm 1 w	16309	
.27	1	Capacitor 0,1 uF	11101	
.28	1	Capacitor 1 uF MKL	11104	
.29	1	Capacitor 4,7 uF MKB	11106	
For RC 2000 with serial No. less or equal to 2165 the descriptions and RC part No. are changed for the following REF. Nos.				
45.00.00	1	Printed Circuit Card 1205-1 complete	35604	
.01	1	Print 1205	35614	
.02	2	Siemens Plug, 15 pins	12205	

Ref.No.	Qty.	Description	RC Part No.	Note
46.00.00	1	Printed Circuit Card 1212 complete	35503	
.01	1	Print 1212	35513	
.02	1	Elco Plug 7023, 35 pins	13707	
.03	6	Transistor SFT 228	11507	
.04	1	Transistor 2N 388	11501	
.05	11	Diode OA 95	11600	
.06	1	Diode OA 200	21303	
.07	1	Resistor 1 K 1/3 w	10411	
.08	1	Resistor 2 K 1/3 w	10418	
.09	5	Resistor 5,6 K 1/3 w	10509	
.10	5	Resistor 6,8 K 1/3 w	10511	
.11	1	Resistor 8,2 K 1/3 w	10513	
.12	5	Resistor 27 K 1/3 w	15908	
.13	1	Resistor 1,5 K 1/2 w	15512	
.14	5	Resistor 3 K 1/2 w	15519	
.15	10	Capacitor 390 pF	15218	
.16	1	Capacitor 680 pF	14903	
.17	1	Capacitor 0,47 uF MKL	11103	
For RC 2000 with serial No. less or equal to 2165 the description and RC part No. are changed for the following REF. Nos.				
46.00.00	1	Printed Circuit Card 1212 complete	35603	
.01	1	Print 1212	35613	
.02	2	Siemens Plug, 15 pins	12205	

Ref.No.	Qty.	Description	RC Part No.	Note
47.00.00	1	Printed Circuit Card 1213 complete	35502	
.01	1	Print 1213	35512	
.02	1	Elco Plug 7023, 35 pins	13707	
.03	1	Transistor SFT 228	11507	
.04	3	Transistor 2N 388	11501	
.05	3	Transistor 2N 2048	11504	
.06	16	Diode OA 95	11600	
.07	8	Diode OA 200	21303	
.08	4	Diode HG 5002	11602	
.09	7	Resistor 1 K 1/3 w	10411	
.10	8	Resistor 2 K 1/3 w	10418	
.11	1	Resistor 3 K 1/3 w	10502	
.12	1	Resistor 4,3 K 1/3 w	10506	
.13	3	Resistor 10 K 1/3 w	10515	
.14	2	Capacitor 1,5 nF	14900	
.15	1	Capacitor 2,2 nF	14904	
.16	1	Capacitor 47 nF	14902	
For RC 2000 with serial No. less or equal to 2165 the description and RC part No. are changed for the following REF. Nos.				
47.00.00	1	Printed Circuit Card 1213 complete	35602	
.01	1	Print 1213	35612	
.02	2	Siemens Plug, 15 pins	12205	

Ref.No.	Qty.	Description	RC Part No.	Note
48.00.00	1	Printed Circuit Card 1224 complete	35501	
.01	1	Print 1224	35511	
.02	1	Elco Plug 7023, 35 pins	13707	
.03	13	Transistor SFT 228	11507	
.04	4	Transistor 2N 388	11501	
.05	8	Diode OA 95	11600	
.06	1	Diode BZY 69	21414	
.07	1	Diode ZF 5,6	21518	
.08	5	Resistor 1 K 1/8 w	10600	
.09	9	Resistor 2 K 1/8 w	10607	
.10	2	Resistor 2,4 K 1/8 w	10609	
.11	1	Resistor 3,9 K 1/8 w	10614	
.12	8	Resistor 5,1 K 1/8 w	10617	
.13	12	Resistor 5,6 K 1/8 w	10618	
.14	10	Resistor 10 K 1/8 w	10704	
.15	1	Resistor 12 K 1/8 w	10706	
.16	8	Resistor 15 K 1/8 w	10708	
.17	1	Resistor 20 K 1/8 w	10711	
.18	1	Resistor 68 K 1/8 w	10804	
.19	3	Capacitor 390 pF	15218	
.20	1	Capacitor 1 nF	15215	
.21	1	Capacitor 1,5 nF	14900	
For RC 2000 with serial No. less or equal to 2165 the description and RC part No. are changed for the following REF. Nos.				
48.00.00	1	Printed Circuit Card 1224 complete	35601	
.01	1	Print 1224	35611	
.02	2	Siemens Plug, 15 pins	12205	

Ref.No.	Qty.	Description	RC Part No.	Note
49.00.00	1	Printed Circuit Card 1227 complete	35500	
.01	1	Print 1227	35510	
.02	1	Elco Plug 7023, 35 pins	13707	
.03	5	Transistor SFT 228	11507	
.04	1	Transistor 2N 388	11501	
.05	1	Transistor ASY 77	21219	
.06	6	Diode OA 85	21301	
.07	5	Resistor 1 K 1/3 w	10411	
.08	2	Resistor 5,6 K 1/3 w	10509	
.09	1	Resistor 2,4 K 1/3 w	10500	
.10	1	Resistor 8,2 K 1/3 w	10513	
.11	2	Resistor 15 K 1/3 w	15902	
.12	1	Resistor 20 K 1/3 w	15905	
.13	1	Resistor 10 K 1/3 w	10515	
.14	2	Capacitor 390 pF	15218	
.15	1	TFA Relay	12909	
For RC 2000 with serial No. less or equal to 2165 the description and RC part No. are changed for the following REF. Nos.				
49.00.00	1	Printed Circuit Card 1227 complete	35600	
.01	1	Print 1227	35610	
.02	2	Siemens Plug, 15 pins	12205	

Ref.No.	Qty.	Description	RC Part No.	Note
		List of Accessories Paper Tape Reader		
	3	Users Manual	GSL 289	
	1	Technical Manual	GSL 287	
	1	Spare Parts Catalog	GSL 446	
	1	Description of I/O signals	GSL 311	
	1	Instruction for Cleaning of Airfilters	GSL 334	
	1	Normal Prism	24715	
	1	Adj. Prism (with ironplate)	24716	
	1	Set of 4 Umbraco Keys No. 1.5 - 22 - 22.5 - 23	20018	
	1	Screw Driver 605/30	24809	
15.01.02	1	Pinch Roller	24602	
19.00.03	1	Tape Drive Capstan	24601	
18.03.08	1	Lamp 8V/50W No. 13113C/04	24702	
20.00.04	2	Fuse 2 Amp.	20806	
24.01.03	2	Fuse 3 Amp.	20808	
24.01.04	4	Fuse 6 Amp.	20811	
	1	Elco Plug type 8016-038-000-004	13713	
	38	Contacts 216-8017.0413	13704	
20.01.00	1	Power Cable 3.5 m	24619	
13.02.00	1	Filter P 15/500	24710	